

Intelligent Storage and Management Solutions for  
Tools, Components and Accessories

**ZOLLER**  
expect great measures

# Smart Cabinets



# Clever Storage Solutions for Networked Manufacturing

## Smart Cabinets

Do you want to work more productively and more economically with efficient tool storage? Then ZOLLER Smart Cabinets are the right choice for you! Your tools will be available when you need them, and because Smart Cabinets are integrated into your production and networked with your software, you can also optimize your tool inventory. This lets you save time previously spent searching and eliminates unnecessary duplicate tool purchases, reduces machine downtimes and delivery times, and allows you to benefit from higher profits all around. Everything you need is available from a single source at ZOLLER.





# Everything Well-Organized

## From Order Receipt to Delivery

All ZOLLER products are linked through the central z.One tool database. This ensures you have access to tool data at every step of the production process, and that you benefit from consistent tool data from CAD/CAM to the warehouse, tool preparation, presetting and measuring to production, inspection and delivery.

Because ZOLLER Smart Cabinets are connected to TMS Tool Management Solutions, storage locations can be displayed graphically in 3D, an overview of minimum inventory levels can be shown, or orders can be triggered with a simple click. This saves time, reduces tool costs and shortens machine downtimes.

Because the storage cabinets are linked to TMS Tool Management Solutions, you can keep an eye on your inventory levels at all times and enjoy intelligent tool management.

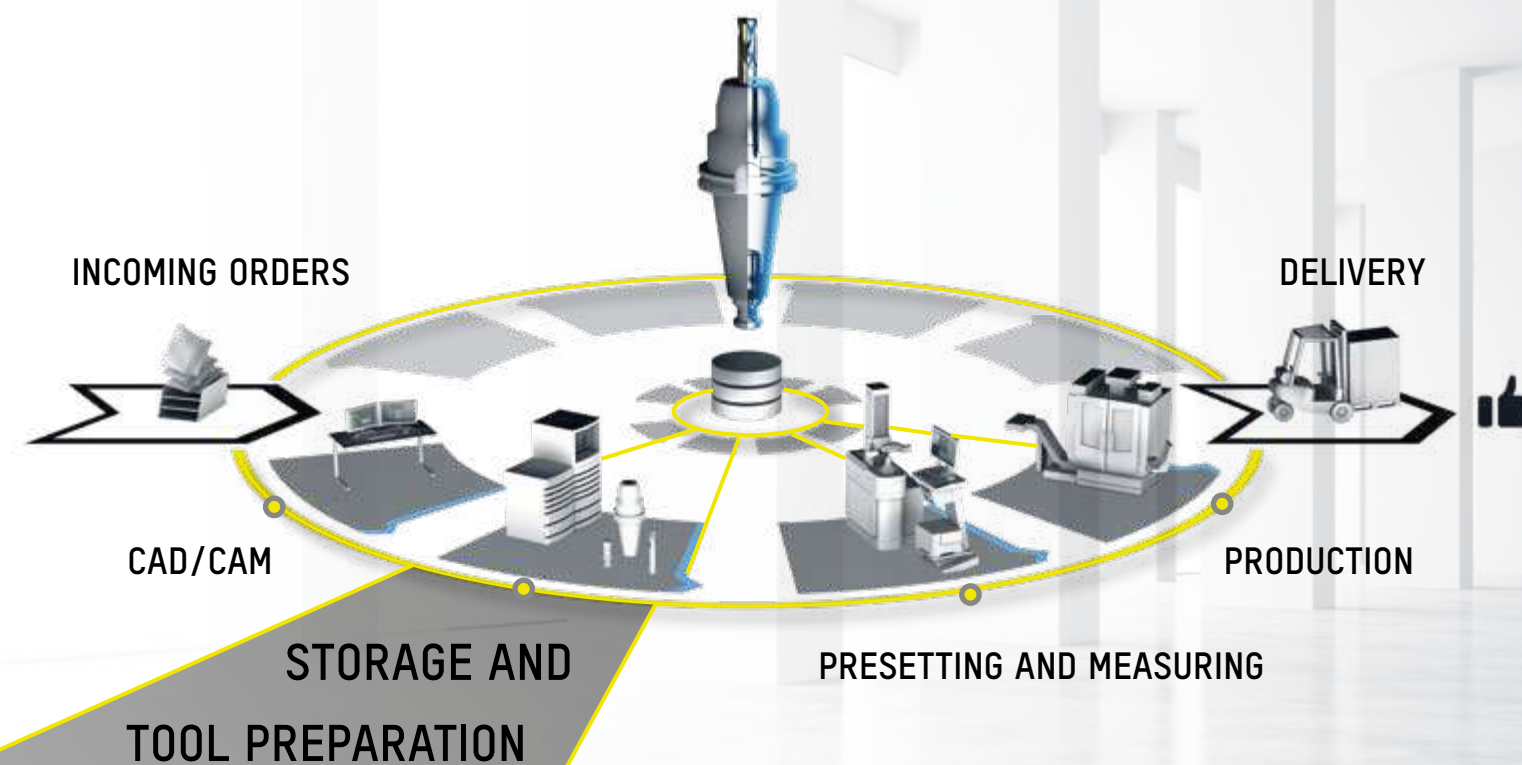

# Your Storage – Your Choice

With Smart Cabinets, you have a say: Would you like to lock your cabinets fully electronically, partially electronically, or fully mechanically? You decide how your cabinets are structured. You also decide which of your employees should have access to which cabinets. All storage areas are shown in the TMS Tool Management Solutions software in a transparent, easy to understand manner. This makes controlled removals and tool bookings more simple than ever before.

- M – mechanically locked
- E – electronically locked
- ✓ – access
- / – no access





# More Order than Ever Before

## All Smart Cabinets at a Glance

No production facility is quite like another; every tool range and warehouse has its own requirements – and we offer the right Smart Cabinet for all of them. No matter whether you want to manage tools and their components, accessories or measurement and testing materials: A variety of components can be stored and managed systematically using the different models. Thanks to a software link, the entire warehouse can be displayed virtually. This ensures you keep your entire warehouse in view at all times, and ensures you benefit from comprehensive organization, save time and money and make your employees' work easier.

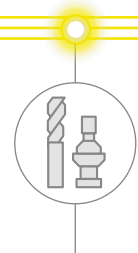
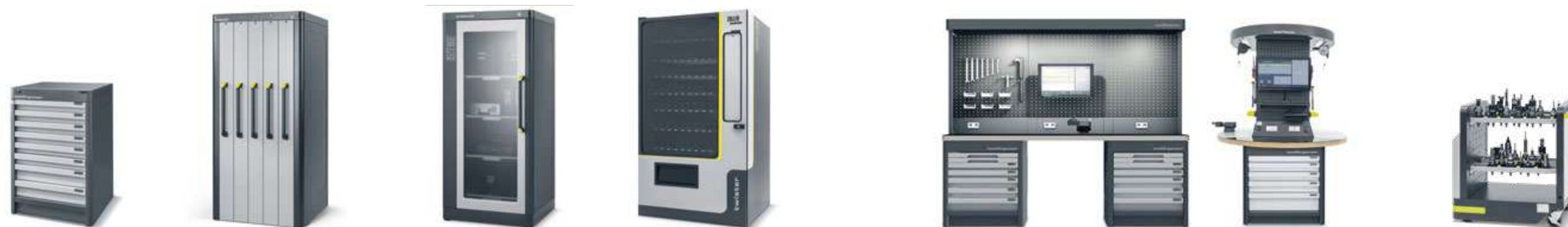

**»toolOrganizer«**  
For Cutting Tools  
and Small Parts

Page  
**10**



**»keeper«**  
For Complete Tools  
and Tool Holders

Page  
**16**



**»autoLock«**  
For Testing Equipment,  
Operating Materials  
and Large Components

Page  
**22**



**»twister«**  
For Tool Components  
and Accessory Parts

Page  
**26**



**»toolStation«**  
For Optimal  
Tool Assembly

Page  
**32**



**»toolTower«**  
For Universal Tool  
Assembly

Page  
**38**



**Tool cart**  
For Convenient Tool  
Transportation

Page  
**44**

# toolOrganizer

## For Cutting Tools and Small Parts

The ZOLLER »toolOrganizer« is the intelligent, variable tool cabinet for cutting tools and small parts. With this organizational wonder connected to TMS Tool Management Solutions, you will always know where items are located and the quantities you have available, meaning you can reorder them on time. And that's not all. You can also restrict quantities removed by user group. This means you can decide exactly how many items are able to be taken out. In addition, you can save cost centers and budgets, re-order tools to meet your needs, avoid lost items in the warehouse and enjoy optimal cost controlling. More than just efficient, that's smart tool management.



**Secure:** The optional central locking mechanism protects against unauthorized access.

**Thoughtful:** The electronics are located in a compact, service-friendly unit.

**Individually assignable:** Drawers can be filled with different partition materials.

**Visual orientation:** LEDs indicate which drawer and which compartment can be opened.

**Custom-tailored:** With drawers of different heights that can be locked both mechanically and electronically.

**Rugged:** Adjustable feet to set up the cabinet even on uneven ground.

Image: »toolOrganizer«  
electronic version and table electronics

### Individually Configurable

How many drawers and compartments do you need? You can assemble your »toolOrganizer« to meet your needs and arrange your products as necessary – for instance by type, priority, or size.

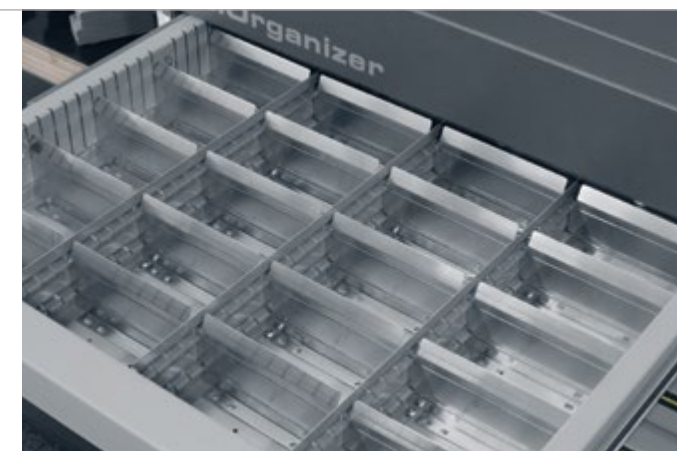

### Maximum Clarity

The display shows the storage locations in the open drawer graphically in 3D. This lets you see at a glance where your selected item is located. This prevents picking errors and mix-ups, and minimizes search times.

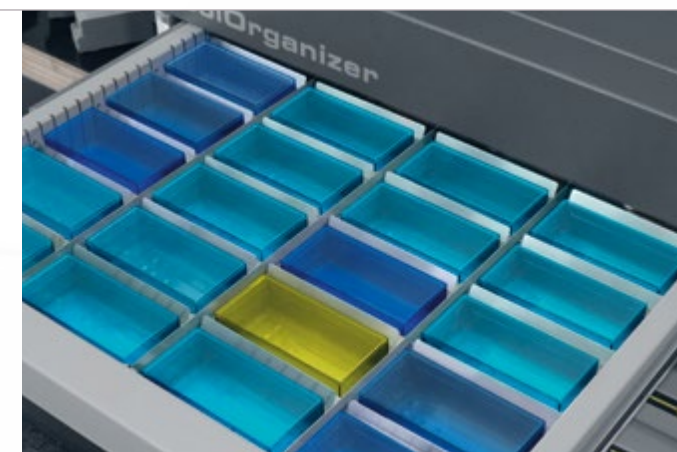

### Full Control and Transparency

The drawers and compartments in the »toolOrganizer« can be activated directly via TMS Tool Management Solutions. This provides you an overview of the movements of all items, and allows you to restrict access – for user groups or quantities removed. Of course, you can also custom configure all of these functions yourself.





# One Cabinet – Multiple Options

## »toolOrganizer« Configuration

01.

### Configurable Usable Height

How much storage do you need?  
How much space is required?  
Thanks to the many different available versions of the »toolOrganizer«, you can assemble your own to meet your needs: in mechanical or electronic versions, with just a few large or multiple small compartments, etc.  
No matter how you decide to configure your »toolOrganizer«, one thing is clear: It always ensures you have the right quantity and the right tool, right at hand.

Height 600 mm



Height 900 mm



Height 1,200 mm



02.

### Design

Locking mechanism with central lock



Electronic drawer lock



Electronic »smartCompartment« single compartment locking

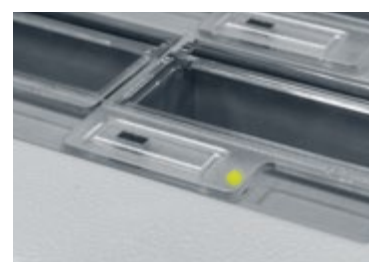

03.

### Control

Table electronics with »quickPick« control software



Separate »cockpit« control unit with »quickPick« control software



TMS Tool Management Solutions Workstation



ZOLLER presetting and measuring machines with Smart Cabinets Software Module



04.

### Drawer Height

Drawer height 50 mm

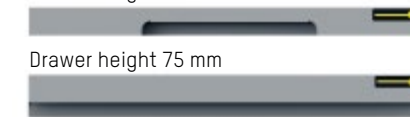

Drawer height 75 mm

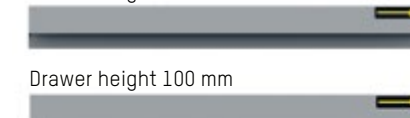

Drawer height 100 mm

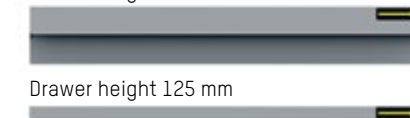

Drawer height 125 mm



Drawer height 150 mm



Drawer height 175 mm

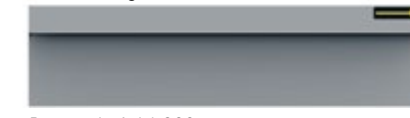

Drawer height 200 mm



Drawer height 250 mm



Drawer height 300 mm



Drawers are always installed in the cabinet from smaller (top) to larger (bottom)

05.

### Drawer Divisions

4 compartments



8 compartments



12 compartments



16 compartments



24 compartments



48 compartments only with 75 mm and 100 mm drawer heights







# keeper

## For Complete Tools and Tool Holders

ZOLLER »keeper« is the optimal solution for storing and managing complete tools and tool holders used in your production process. Thanks to networking with TMS Tool Management Solutions, it ensures you can view the storage locations of your complete tools at all times.

**Bullseye:** Pull-out drawers can be locked mechanically or electronically. With the electronic version, the right drawer is marked by an LED light and unlocked.

**Ergonomic:** Wide handles ensure the drawer can be easily extended with one hand, even when heavily loaded. Each drawer can handle up to 1,000 kg.

**Flexible:** The tool frames are height adjustable, ensuring you can store tools of all sizes.

**Comprehensive:** Specially configured, space-saving tool inserts are available for all common systems.

**Rugged:** Adjustable feet ensure the »keeper« can be placed securely even on uneven ground.

**Comfortable:** Drawers are easy to move thanks to high-quality, heavy-duty rollers.



## A Place for Everything

Operation of the »keeper« is extremely convenient. The handles are large, making it simple to pull out the drawers. Thanks to a variety of ZOLLER tool inserts, tools with different tool holders, such as SK, HSK, VDI or Capto can be stored.



## Tool Navigator

The tool's storage location in the cabinet is displayed on the screen in 3D. After the software releases the drawer on the »keeper«, the drawer is unlocked and the tool can be removed.

## Clearing Things Up

Notification LEDs on the drawers indicate the drawer where the requested tool is located. This reduces time spent searching and ensures better efficiency in work processes.



# Fits Your Needs – And Everything Fits

»keeper« Configuration

01.

## Cabinet Height and Drawers

No matter how many or which complete tools and tool holders are in use in your production: »keeper« can adapt flexibly to meet your requirements. Configure it for yourself!

2,000 mm high with 5 drawers



2,000 mm high with 3 drawers



1,000 mm high with 5 drawers



1,000 mm high with 3 drawers



02.

## Design

Mechanical design



Electronic design



03.

## Control

Table electronics with »quickPick« control software



Side-mounted panel PC for »keeper 2000«



Separate »cockpit« control unit with »quickPick« control software



TMS Tool Management Solutions workstation



ZOLLER presetting and measuring machines with Smart Cabinets software module



04.

## Division

6 tool frames are included in the scope of delivery as a standard for each drawer for the keeper 2000, and 3 for the keeper 1000.



Tool frames

Tool inserts



# Technical Data

»keeper«

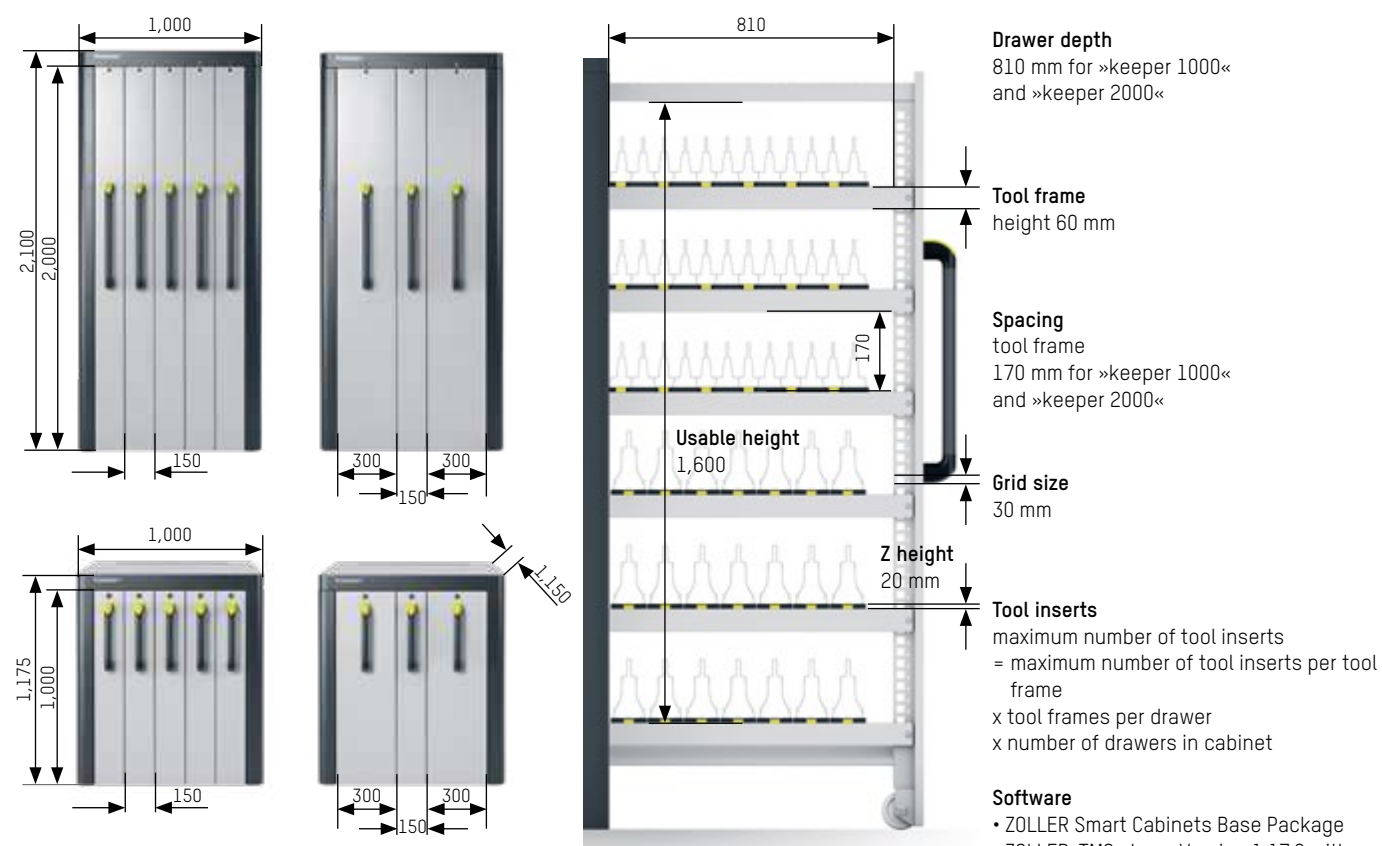

**»keeper« specifications**

- Max. tool diameter**  
150 mm (with 5 drawers)  
300 mm (with 3 drawers)
- Max. weight per vertical pull-out drawer**  
1,000 kg
- Electrical connection values**  
230 V / 50 Hz / < 1 kVA
- Drawer depth**  
810 mm
- Tool frame spacing with standard filling**  
170 mm
- Compartment height**  
Variably configurable

**»keeper 2000« specifications**

- Dimensions (H x W x D)**  
2,100 x 1,000 x 1,050 mm
- Empty weight**  
430 kg
- Capacity**
  - 3 or 5 vertical pull-out drawers with 6 tool frames each
  - 6 tool frames are included in the scope of delivery – additional frames available upon request

**»keeper 1000« specifications**

- Dimensions (H x W x D)**  
1,175 x 1,000 x 1,050 mm
- Empty weight**  
270 kg
- Capacity**
  - 3 or 5 vertical pull-out drawers with 3 tool frames each and a basin for small parts boxes for accessories

- Software**
  - ZOLLER Smart Cabinets Base Package
  - ZOLLER-TMS above Version 1.17.0 with interface (Art. no. 8774203)
  - Integration ZOLLER-TMS-Software

- Note**  
Cabinet contents (tools, single components) are not included in the scope of delivery. »keeper« are also available without activation.  
Up to 9 ZOLLER Smart Cabinets can be connected in series and operated with one control with the electronic version. The following controls can be used:
  - Table electronics
  - Separate »cockpit« control unit
  - TMS Tool Management Solutions workstation (external computer)
  - ZOLLER presetting and measuring machine
  - Side-mounted panel PC for »keeper 2000«



Tool inserts		Accessories	Size		Width (mm)	Max. Number Per Frame
L	S		S	L		
		Tool insert SK 30	•		72	14
		Tool insert SK 40				
		Tool insert SK 50		•	95	8
		Tool insert HSK 25, 32	•		72	14
		Tool insert HSK 40				
		Tool insert HSK 50				
		Tool insert HSK 63	•	•	72 or 95	14 or 8
		Tool insert HSK 80				
		Tool insert HSK 100		•	95	7
		Tool insert VDI 30	•		72	14
		Tool insert VDI 40				
		Tool insert Capto C4	•		72	14
		Tool insert Capto C5				
		Tool insert Capto C6				
		Tool insert (blank) B58			85	8
		Tool insert (blank) B75			75	8
		Tool insert (blank) B120			120	8
		Insert D 78 VSH size 1			95	7
		Insert D 92 VSH size 2/Adapter GA			130	6
		Wooden insert (blank)			328	2
		D 42 14 Drill holes			328	2
		Basin insert for small parts			810	1
		Open storage container for basin insert			103	8

»keeper«: Tool Insert Complete Package	Accessories	»keeper 2000« Number	»keeper 1000« Number
	Tool inserts SK 40 S	390	195
	Tool inserts HSK 63 S	390	195
	Tool inserts HSK 63 L	240	120
	Tool inserts VDI 30	390	195
	Tool inserts Capto C6	390	195

# autoLock

## For Testing Equipment, Operating Materials and Large Components

Everything ready to go: The »autoLock« storage cabinet, in combination with TMS Tool Management Solutions, makes sure you are always ready. Manual and power tools, gauges, measuring machines and lubricants can be locked securely and are easily accessible. The control software allows you to manage access authorizations and swap out objects with integrated access control.



Practical: Automatic door unlocking after release in the software

Design: 4 to 9 pull-out drawers for clear storage of your items

### Visibly Secure

Until the door is released in the tool management software, items are securely protected against unauthorized access by an electronic door lock. An LED indicates when the door is unlocked and can be opened.



### Where are the Testing Materials?

Once you have added them in the tool management, you can trace where items you are looking for are stored with just a click. The easy to understand graphic software interface shows you which cabinet and which drawer they are located in.

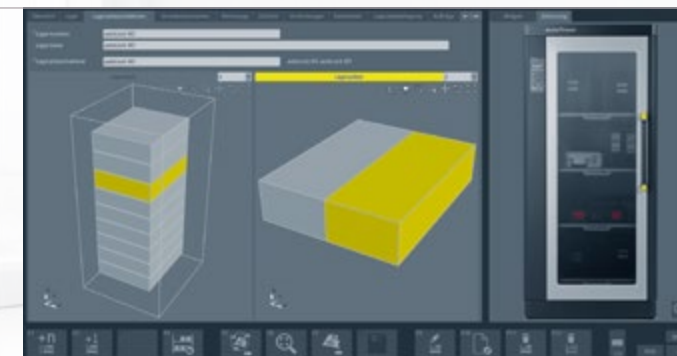

### Completely Extendable

The storage shelves can be fully extended. This makes it convenient to see and access even items stored in the back.





# Technical Data

»autoLock«



## »autoLock« specifications

**Dimensions (H x W x D)**  
2,100 x 1,000 x 1,055 mm (exterior)  
1,900 x 650 x 790 mm (interior)

**Weight**  
250 kg

**Electrical connection values**  
230 V / 50 Hz / < 1 kVA

**Compartment dimensions (W x D)**  
660 mm x 900 mm

**Payload per compartment**  
80 kg

## Optional

- Up to 9 extendable compartments (minimum distance of 200 mm with a max. load height of 150 mm)
- Mechanical instead of electronic lock

## Software

- ZOLLER Smart Cabinets Base Package
- ZOLLER-TMS above Version 1.17.0 with interface (Art. no. 8774203)
- ZOLLER-TMS software integration

## Note

Stored items shown are not included in the scope of delivery. Up to 9 ZOLLER Smart Cabinets can be connected in series and operated with one control with the electronically controlled versions.

- Side-mounted panel PC with 24" monitor
- Separate »cockpit« control unit
- TMS Tool Management Solutions workstation (external computer)
- ZOLLER presetting and measuring machine



Practical: The storage location of the item you are searching for is highlighted graphically in the TMS Tool Management Solutions software.

An ideal choice for structured, clear storage: With »autoLock«, you benefit from easy accessibility for maximum user convenience, and from a thoughtful design with space for items large and small.



# twister

## For Tool Components and Accessory Parts

With »twister«, you can not only store small cutting tools, cutting insert packages, maintenance, repair and operating materials, but other small parts as well. Thanks to a connection to TMS Tool Management Solutions, you always have an overview of your current inventory levels. You benefit from precise circulation controlling and storage transparency and can reorder items in a timely manner. You can trace and analyze one hundred percent of removals, thanks to seamless documentation.

Flexible: 7 compartment levels with different coiled spirals.

Convenient and secure: Large grip flap with padded base for comfortable access and to protect items during removal.



### Adaptable

»twister« is available in sizes S and L. »twister« S offers space for 6 spirals, »twister« L for 10 spirals per level.

The spirals on the levels are available with different windings, so that 10 to 24 items can be stored per spiral and so as to provide space for items of all sizes.



### Everything in View

»twister« is activated via the TMS Tool Management Solutions software. This allows the user to keep stock levels in view at all times and reorder directly when they are low.

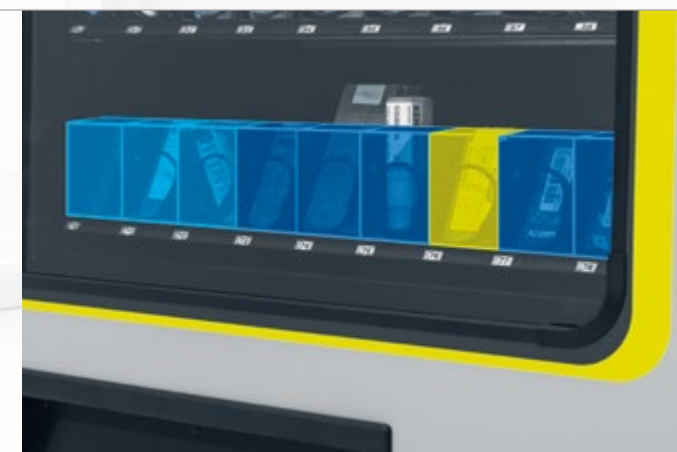

### Simple Access

The storage levels can be pulled out for easy loading. This means items can be stored quickly – ideal for frequently used materials.





# 1,2,3 – done!

## »twister« Configuration

### 01.

#### Cabinet Size

Organize once, and then never search again: Configure your custom »twister«. You can select the width of the storage cabinet and number of storage spaces to meet your needs, as well as the type of control used.

»twister« L: Width 990 mm  
Height 1,830 mm



»twister« S: Width 724 mm  
Height 1,830 mm



»microtwister«: Width 565 mm  
Height 1,030 mm



### 02.

#### Control

Separate »cockpit« control unit with »quickPick« control software



TMS Tool Management Solutions workstation



ZOLLER presetting and measuring machines with Smart Cabinets software module



### 03.

#### Design

»twister« L

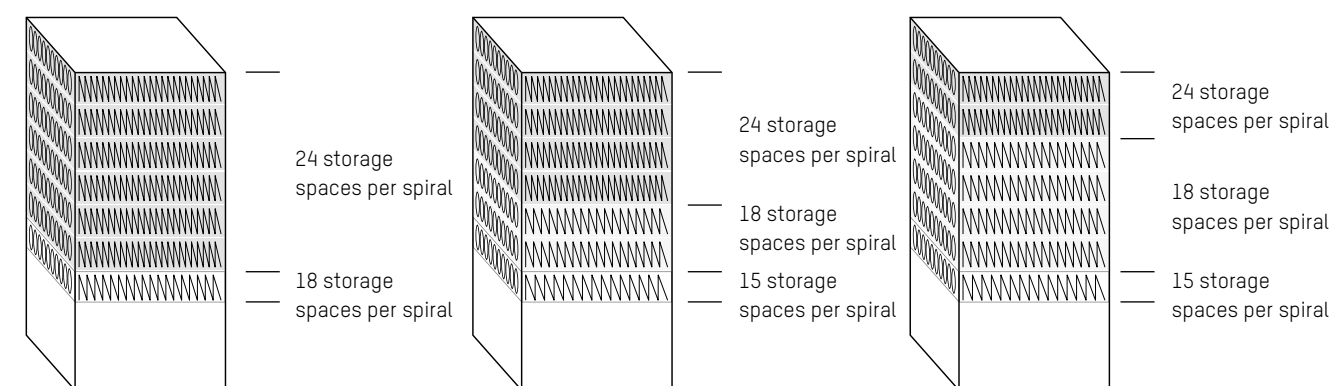

»twister« S

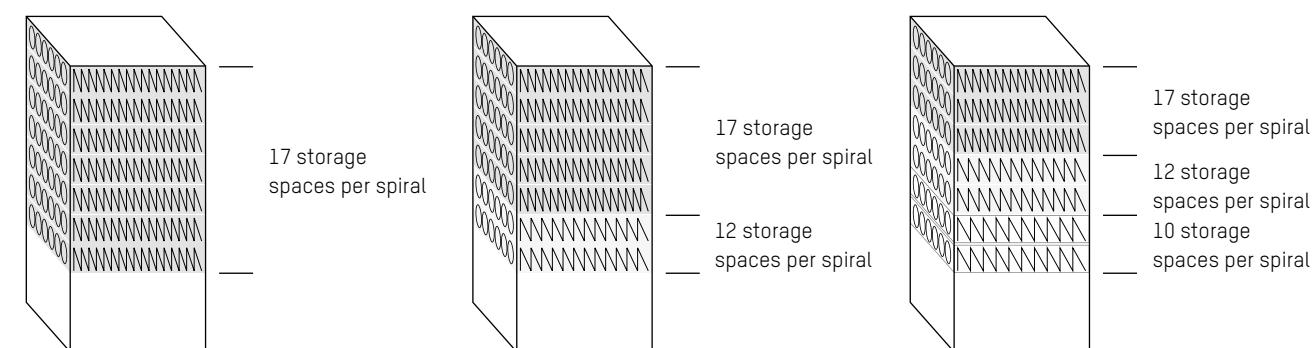

»microtwister«

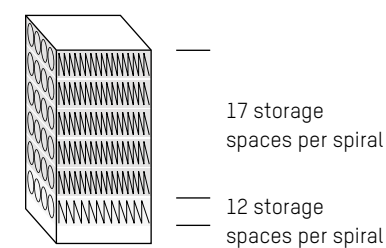

# Technical Data

»twister«

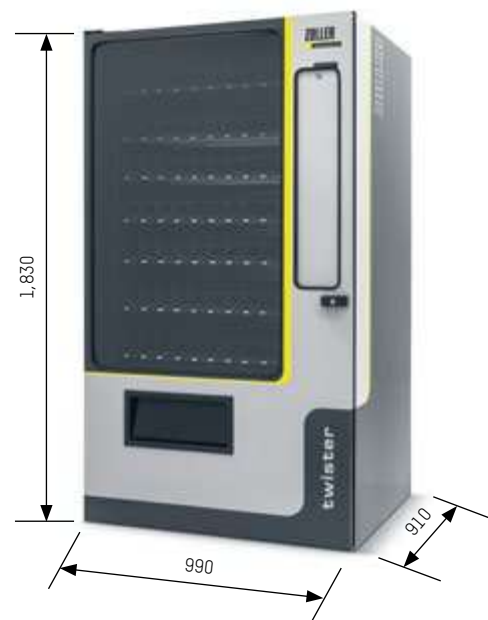

**»twister«, Version L Specifications**

**Dimensions (H x W x D)**  
1,830 x 990 x 910 mm

**Empty weight**  
247 kg

**Maximum load weight per level**  
36 kg

**Maximum load weight per spiral**  
4.5 kg

**Electrical connection values**  
230 V / 50 Hz / < 1 kVA

**»twister«, Version S Specifications**

**Dimensions (H x W x D)**  
1,830 x 724 x 750 mm

**Empty weight:**  
190 kg

**Maximum load weight per compartment**  
36 kg

**Maximum load weight per spiral**  
4.5 kg

**Electrical connection values**  
230 V / 50 Hz / < 1 kVA

**»microtwister« specifications**

**Dimensions (H x W x D)**  
1,030 x 565 x 635 mm

**Empty weight:**  
81 kg

**Maximum load weight per compartment**  
36 kg

**Maximum load weight per spiral**  
4.5 kg

**Electrical connection values**  
230 V / 50 Hz / < 1 kVA



**Software**

- ZOLLER Smart Cabinets Base Package
- ZOLLER-TMS above Version 1.17.0 with interface (Art. no. 8774203)
- Integration ZOLLER-TMS-Software

**Note**

Stored items shown are not included in the scope of delivery. Up to 9 ZOLLER Smart Cabinets can be connected in series and operated with one control with the electronic version.

- Separate »cockpit« control unit
- TMS Tool Management Solutions workstation (external computer)
- ZOLLER presetting and measuring machine

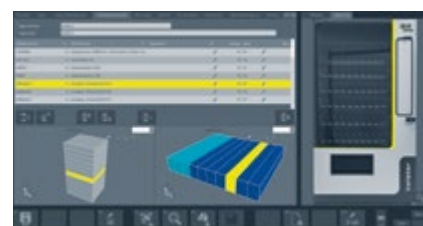

Practical: The storage location of the item you are searching for is highlighted graphically in the TMS Tool Management Solutions software.

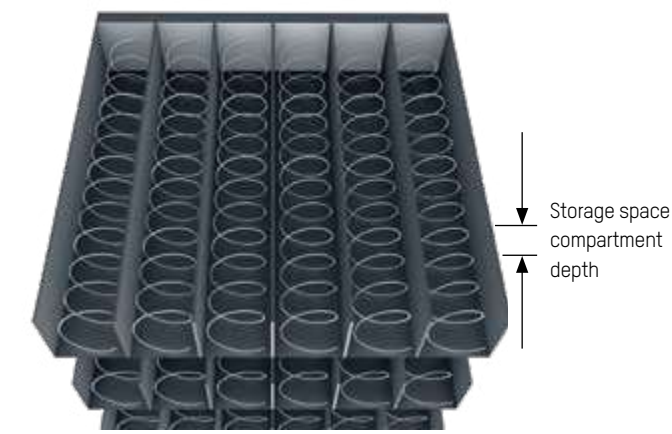
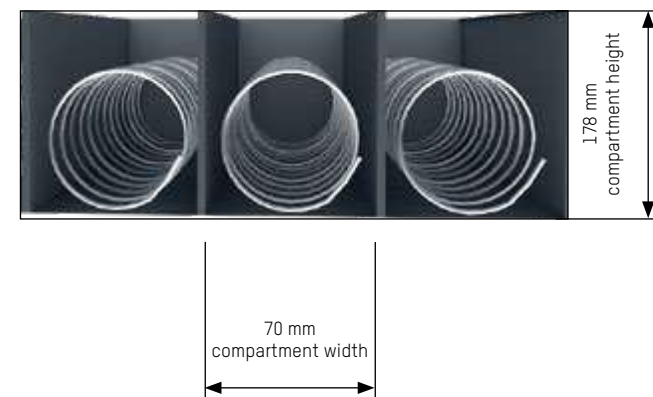

»twister« with levels, spirals and storage spaces

	»twister« L 10 Spirals per Level			»twister« S 6 Spirals per Level			»microtwister« S 4 spirals per Level									
	Confi. 1	Confi. 2	Confi. 3	Confi. 1	Confi. 2	Confi. 3	Confi. 1									
Number of Levels	6	1	4	2	1	2	4	1	7	5	2	3	2	2	5	1
Number of Storage Spaces	24	18	24	18	15	24	18	15	17	17	12	17	12	10	17	12
Compartment Depth in mm	23	31	23	31	33	23	31	33	19	19	26.5	19	26.5	33	19	26.5
Total Number of Storage Spaces	1,620		1,470		1,350	714		654	388		388					

The configurations of the »twister« material dispensers differ in the number of spiral coils. One level is always equipped with the same spirals. There are seven levels in each cabinet.



# toolStation

## For Optimal Tool Assembly

Everything you need for economical tool (data) handling from a single source. With the »toolStation« workbench from ZOLLER, you can complete your tool storage and offer your employees a comfortable work area for tool assembly: with optimal lighting and clearly arranged assembly tools.

Clever: Up to two »toolOrganizer« can be housed under the workbench – for fast access to components and accessories.

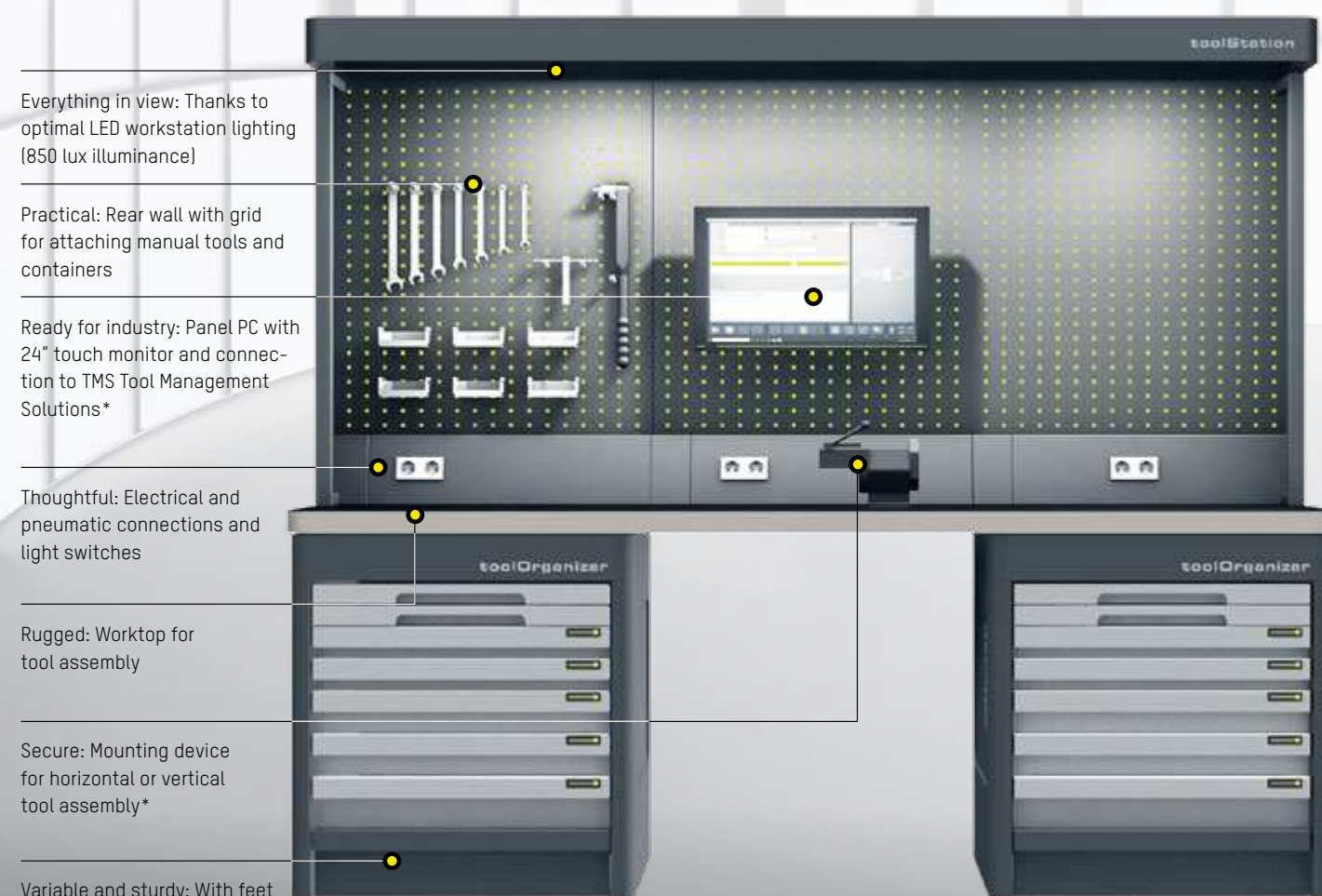

Everything in view: Thanks to optimal LED workstation lighting (850 lux illuminance)

Practical: Rear wall with grid for attaching manual tools and containers

Ready for industry: Panel PC with 24" touch monitor and connection to TMS Tool Management Solutions\*

Thoughtful: Electrical and pneumatic connections and light switches

Rugged: Worktop for tool assembly

Secure: Mounting device for horizontal or vertical tool assembly\*

Variable and sturdy: With feet on the base cabinet or the »toolOrganizer 600«, the »toolStation« is solid as a rock

## Everything Within Reach

Required tools can be placed securely on the rear wall with hole pattern. Background lighting ensures comfortable working conditions.

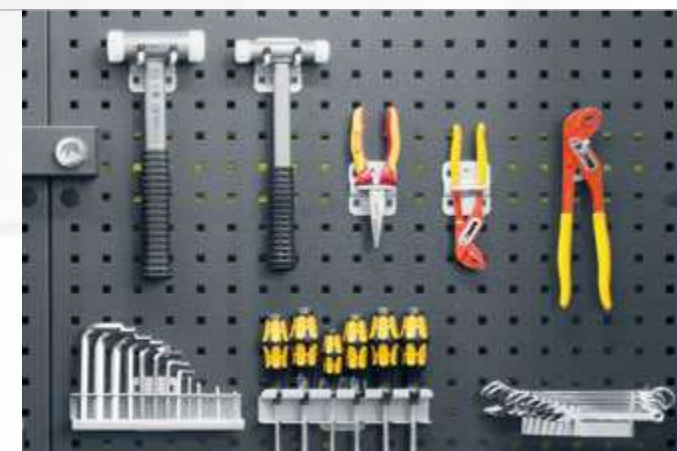

## Convenient Tool Assembly

The permanently installed mounting device makes safe horizontal and vertical tool assembly easier. Along with the optimal lighting, comfortable working height and connections and tools within reach, the »toolStation« offers everything workers need for comfortable, precise work.



## Connection to Tool Management

The »toolStation« is connected to TMS Tool Management Solutions through either a control unit mounted on the rear wall or a separate control unit.

This means the »toolOrganizer 600« integrated into the workbench, for instance, can be activated directly, and items can be checked out and removed and drawings and parts lists can be displayed.



# 2 Steps to the »toolStation«

## »toolStation« Configuration

01.

### Size and Design

Width 3,000 mm



»toolStation« with rear wall (can be placed on the right or left side) and 2 »toolOrganizer 600«



»toolStation« with rear wall, monitor bracket and one »toolOrganizer 600« (»toolOrganizer« and rear wall can be placed on either the left or right)



»toolStation« without rear wall, with monitor bracket, power strip and two »toolOrganizer 600«



»toolStation« without rear wall, without power strip and with one »toolOrganizer 600«

Width 2,450 mm



»toolStation« with rear wall and two »toolOrganizer 600«



»toolStation« with rear wall and one »toolOrganizer 600«



»toolStation« without rear wall, with power strip and two »toolOrganizer 600«



»toolStation« without rear wall, without power strip and with no »toolOrganizer 600«

Width 1,630 mm



»toolStation« with rear wall and one »toolOrganizer 600«



»toolStation« without rear wall, with power strip and one »toolOrganizer 600«



»toolStation« without rear wall, without power strip and one »toolOrganizer 600«



»toolStation« without rear wall, without power strip and with no »toolOrganizer 600«

Note: »toolOrganizer 600« configuration on page 12

02.

### Control

Panel PC for attachment to the work bench table



Panel PC for attachment to the rear wall using »quickPick« control software



TMS Tool Management Solutions workstation





# Technical Data

## »toolStation«

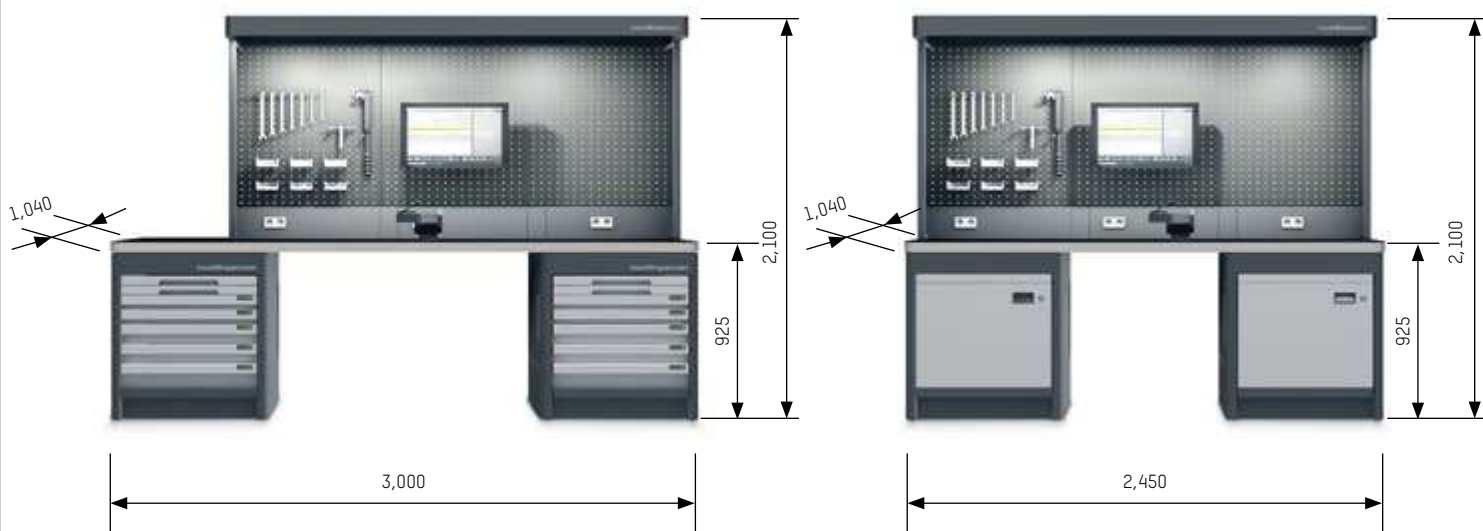

»toolStation« large, with rear wall and 2 »toolOrganizer«  
 Total height including rear wall 2,100 mm  
 Worktop height 925 mm  
 Workbench width 3,000 mm  
 Workbench depth 1,040 mm

»toolStation« large, with rear wall and 2 base cabinets  
 Total height including rear wall 2,100 mm  
 Worktop height 925 mm  
 Workbench width 2,450 mm  
 Workbench depth 1,040 mm



Small »toolStation«, without rear wall, with power strip and one »toolOrganizer«  
 Total height including power strip 1,098 mm  
 Worktop height 925 mm  
 Workbench width 1,630 mm  
 Workbench depth 1,040 mm

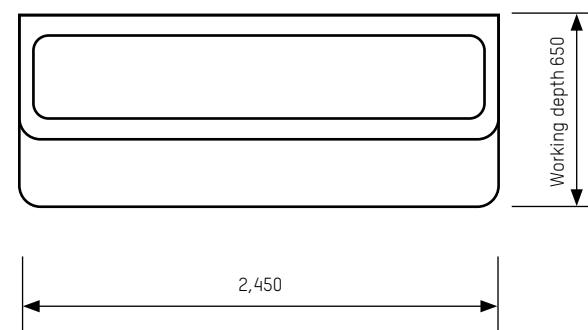

»toolStation« top view with 2,450 mm width

# Options

### Large »toolStation« specifications

Total height including rear wall 2,100 mm

Worktop height 925 mm

Workbench width 2,450 mm, 3,000 mm

Workbench depth 1,040 mm

### Small »toolStation« specifications, without rear wall

Total height including power strip 1,098 mm

Worktop height 925 mm

Workbench width 1,630 mm

Workbench depth 1,040 mm

### Software

- ZOLLER Smart Cabinets Base Package
- ZOLLER-TMS above Version 1.17.0 with interface (Art. no. 8774203)
- Integration ZOLLER-TMS-Software

### Note

Accessories shown, such as manual tools, are not included in the scope of delivery. The energy supply can be fed from either the top or bottom.

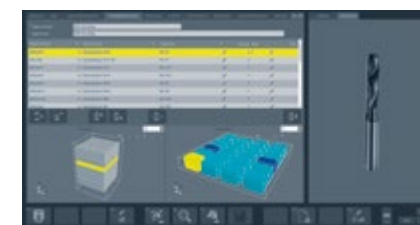

Practical: The storage location of the item you are searching for is highlighted graphically in the TMS Tool Management Solutions software.

Note: »toolOrganizer 600« configuration on page 12

1

Panel PC incl. keyboard and mouse storage board for attachment to the rear wall for using TMS Tool Management Solutions directly at the workplace



2

Panel PC incl. keyboard and mouse storage board for using TMS Tool Management Solutions on the worktop



3

»toolOrganizer 600« for storing single components within reach



4

Base cabinet with 50 mm push-to-open drawer and fixed or extendable interior insert compartments



5

Assembly hook set for hanging assembly tools on the rear wall



6

Tool assembly device for mounting and clamping tool holders such as HSK, SK, Capto, VDI



7

Energy duct with pneumatic and electronic connections



8

Plexiglas panel for a quick, easy to clean worktop



# toolTower

## For Universal Tool Assembly

Assembly made easy – with the ZOLLER »toolTower«. It offers up to four comfortable and central assembly stations. You can hang assembly hooks on the rear wall, which is equipped with a lighting system – a practical option for your manual tools and other accessories.

Our recommendation: Place a »toolOrganizer« under the mounting panel. This ensures you have all the single components and accessories you need at hand right away.

Everything in view: Thanks to optimal workstation lighting (850 lux illuminance)

Ready for industry: Panel PC with 24" touch monitor and connection to TMS Tool Management Solutions\*

Practical: Rear wall with hole pattern for attaching manual tools and containers

Secure: Mounting device for horizontal or vertical tool assembly\*

Rugged: Worktop for tool assembly

Thoughtful: Electrical and pneumatic connections and switches in the power strip

Variable and sturdy: With feet on the base cabinet or the »toolOrganizer 600«, the »toolTower« is solid as a rock



## Everything Within Reach

Required tools can be placed securely on the rear wall with hole pattern. Background lighting guarantees comfortable working conditions.



## Accessible from Every Direction

The »toolTower« offers space for four assembly stations, making it an optimal central focal point for efficient tool assembly.

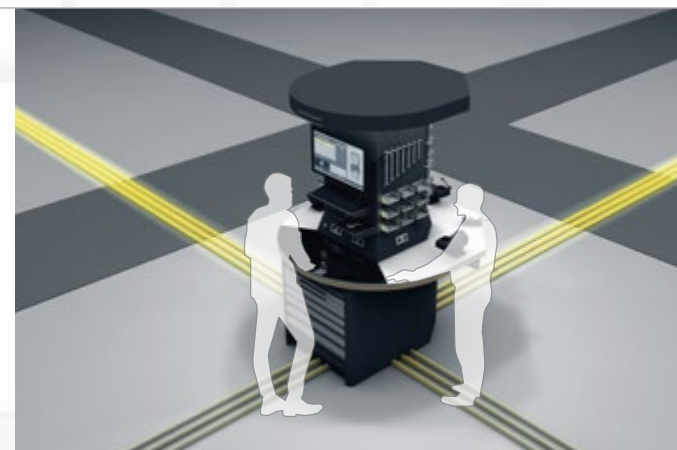

## Connection to Tool Management

The »toolStation« is connected to TMS Tool Management Solutions through either a control unit mounted on the rear wall or a separate control unit.





# Choose Your »toolTower«

## »toolTower« Configuration

Do you have several employees who prepare and assemble tools every day? Do you want to find an efficient, space-saving solution for their work? Then our »toolTower« is the right choice for you. Just select your version – and you're done.

01.

### Design



Note: All versions are also available without a panel PC.  
»toolOrganizer 600« configuration on page 12.

02.

### Drawers



03.

### Drawer Height

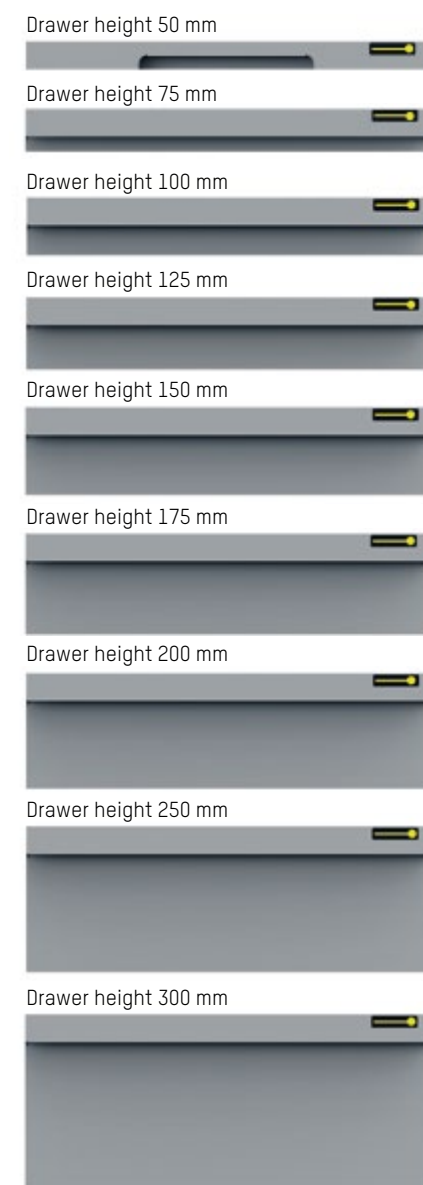

Drawers are always installed in the cabinet from smaller (top) to larger (bottom)

04.

### Drawer Divisions

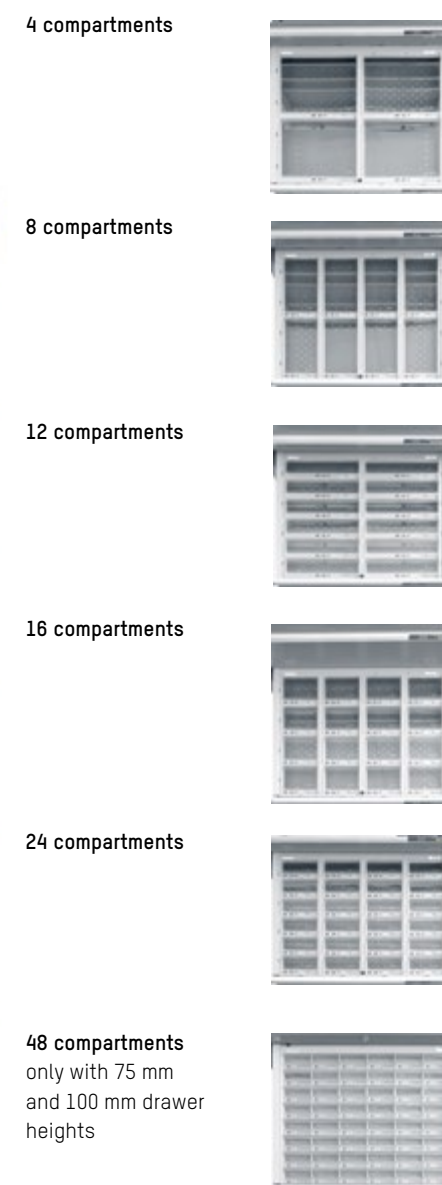

# Technical Data

»toolTower«



## »toolTower« Specifications

**Total height including rear wall**  
2,100 mm

**Worktop height**  
925 mm

**»toolTower« width**  
1,490 mm

**»toolTower« depth**  
1,595 mm

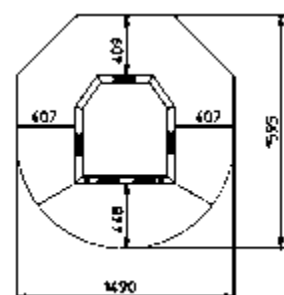

## Rear wall with hole pattern

**Grid spacing**  
9 x 9 mm

**Dividing grid**  
37 mm

## Software

- ZOLLER Smart Cabinets Base Package
- ZOLLER-TMS above Version 1.17.0 with interface (Art. no. 8774203)
- Integration ZOLLER-TMS-Software

## Note

Accessories shown, such as manual tools, are not included in the scope of delivery. The energy supply can be fed from either the top or bottom.



## »toolTower« Specifications Basic Version

**Total height including rear wall**  
2,010 mm

**Worktop height**  
914 mm

**»toolTower« width**  
1,260 mm

**»toolTower« depth**  
1,260 mm

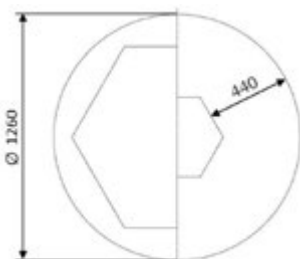

## Rear wall with hole pattern

**Grid spacing**  
10 x 10 mm

**Dividing grid**  
37 mm

## Note

Accessories shown, such as manual tools, are not included in the scope of delivery. The energy supply can be fed from either the top or bottom.

# Options

1

\* Panel PC incl. keyboard and mouse storage board for using TMS Tool Management Solutions directly at the workplace



2

\* »toolOrganizer 600« for storing single components within reach



3

\* Base cabinet with 50 mm push-to-open drawer and fixed or extendable interior insert compartments.



4

Assembly hook set for hanging assembly tools on the rear wall

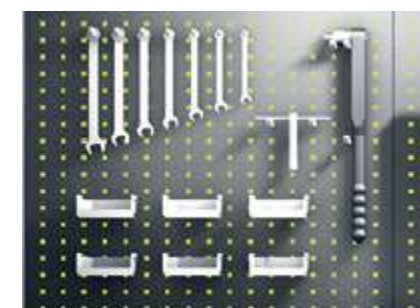

5

Tool assembly device for mounting and clamping tool holders such as HSK, SK, Capto, VDI



6

\* Plexiglas panel for a quick, easy to clean worktop



7

\* Energy duct with pneumatic and electronic connections



8

Pneumatic connection for the »toolTower« assembly island as basic version



9

Lighting package: Workplace lighting with 24W LED luminaire (850 lux) for the »toolTower« assembly island as basic version.



\* No option for »toolTower« as basic version



# Tool Cart

## For Convenient Tool Transportation

Always ready for use: With ZOLLER tool carts, you can stay mobile in production, transporting tools, attachment holders and adapters comfortably and safely at all times.

Flexible: Tool frames can be attached to the universal grid on the side walls – for complete tools of many different sizes

Practical: Storage area for paper and drawings

The tool cart is also available with optional drawers, an oil pan or an additional storage board

High-quality, workshop-ready castors with brake

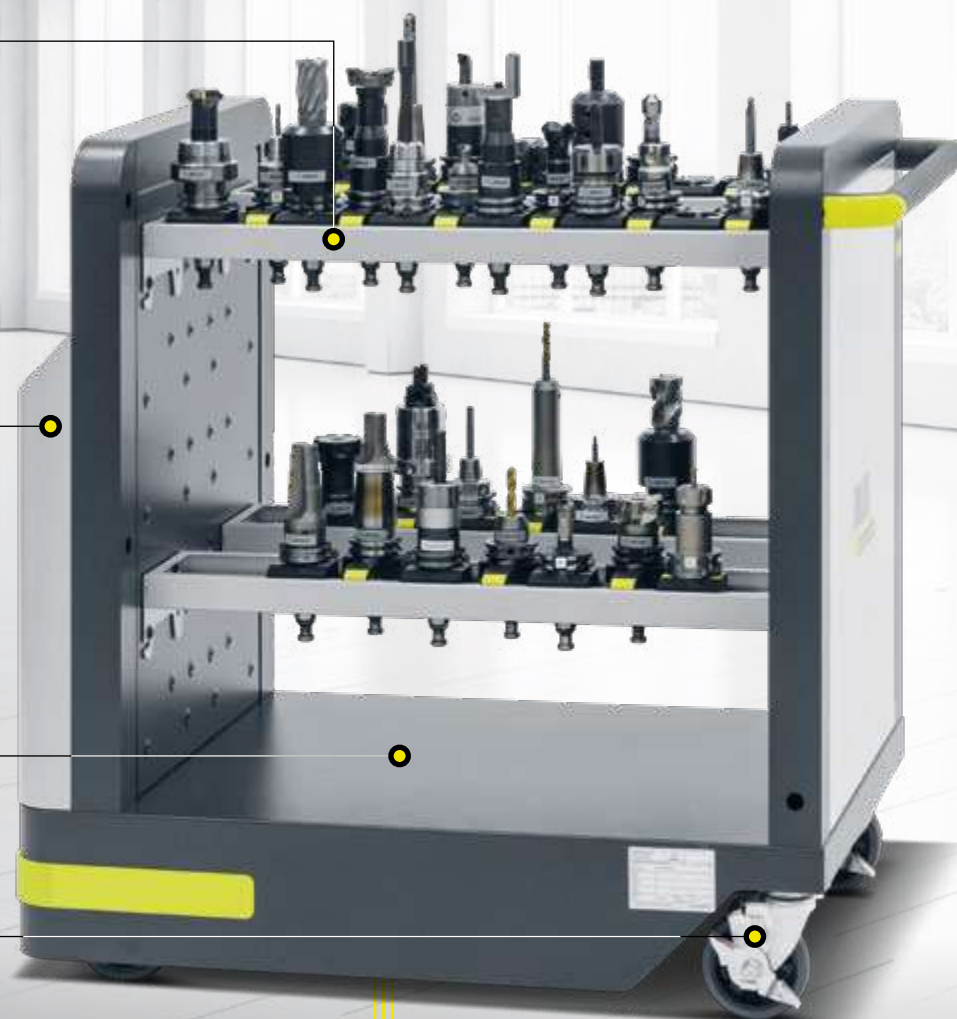

## Handles a Full 450 kg

Extremely sturdy: Thanks to its stable design, you can use a ZOLLER tool cart filled with 9 tool frames to transport up to 108 tools with a total load of up to 450 kg. The Y-shape of the tool inserts makes it possible to mount even more tools per frame using a zipper principle.

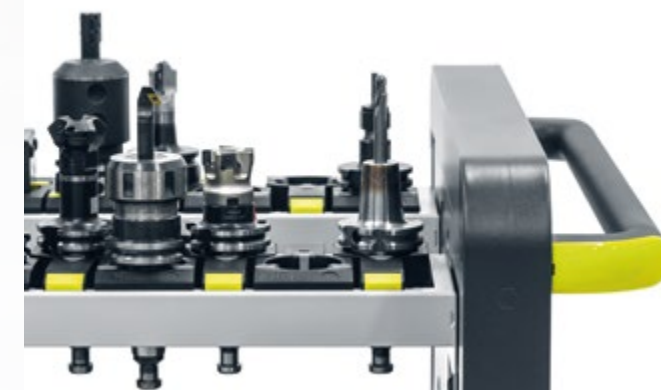

## Readily Available and On Site

Tools, adapters and attachment holders are always available and secure, for instance beside the presetting and measuring machine. Users can also bring along drawings and other inspection materials thanks to optional storage areas.

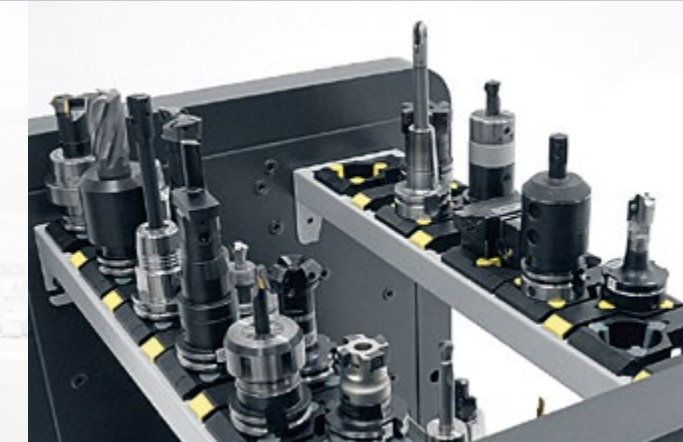

## Flexible Use

Up to five tool frames for holding complete tools of many different sizes in the tool cart. Thanks to the optimal grid on the frame inside the cart, you can position the frame in the most convenient way for you.



# Technical Data

## Tool Cart

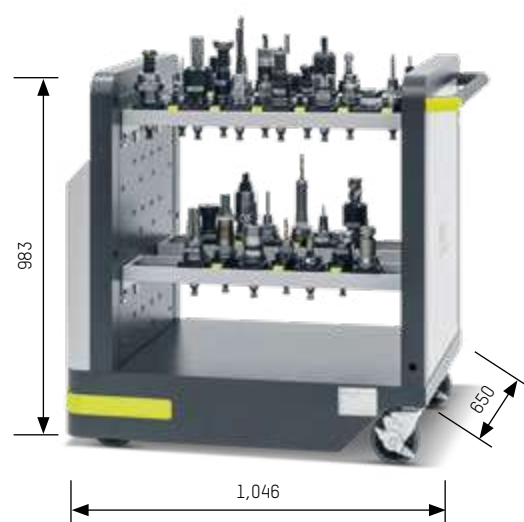

### Tool Cart Specifications

**Dimensions (H x W x D)**  
983 x 650 x 1,046 mm

**Exchangeable frame length**  
730 mm

**Note**  
Tools and tool holders are not included in the scope of delivery. An optional protective frame protects against injury from the tools.

### Tool insert S

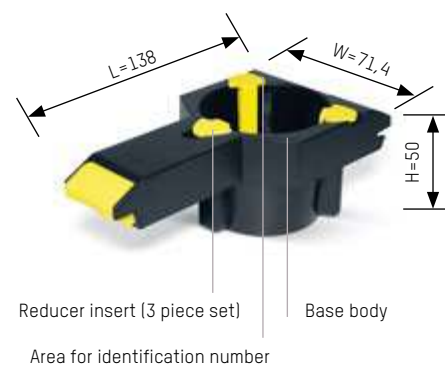

### Tool insert L

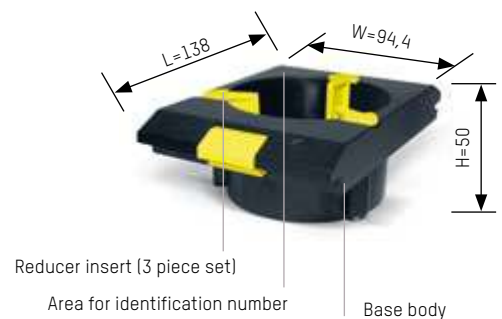

Tool Inserts		Accessories	Size		Width (mm)	Max. Number per Frame
L	S		S	L		
		Tool insert SK 30	●		72	13
		Tool insert SK 40				
		Tool insert SK 50		●	95	7
		Tool insert HSK 25, 32	●		72	13
		Tool insert HSK 40				
		Tool insert HSK 50	●	●	72 bzw. 95	13 bzw. 7
		Tool insert HSK 63				
		Tool insert HSK 80		●	95	7
		Tool insert VDI 30	●		72	13
		Tool insert VDI 40				
		Tool insert Capto C4	●		72	13
		Tool insert Capto C5				
		Tool insert Capto C6				
		Tool insert (blank) B58			85	7
		Tool insert (blank) B75			75	7
		Tool insert (blank) B120			120	7
		Insert D 78 VSH size 1			95	7
		Insert D 92 VSH size 2/Adapter GA			130	6
		Wooden insert (blank)			328	2
		D 42 14 Drill holes			328	2

ZOLLER Standard Tool Carts each contains 5 tool frames for holding the tool inserts	Accessories	Number (pieces)
	ZOLLER tool cart Standard SK 40	60
	ZOLLER tool cart Standard SK 50	35
	ZOLLER tool cart Standard HSK 63	60
	ZOLLER tool cart Standard HSK 63 L	35
	ZOLLER tool cart Standard Capto C6	60



”

Michael Trebing, Area Manager of Production at SIM Automation GmbH, Heilbad Heiligenstadt, discusses the advantages of ZOLLER TMS Tool Management Solutions software and hardware

## Significant Savings

“One major benefit of the ZOLLER system is the company's openness to third-party systems – including their readiness to develop new interfaces. Another advantage is the graphical display of tool storage locations with the tool management software – this lets you know directly where the item you need is located and prevents you from having to search for it. And since we have consistent data and an overview of tool circulation thanks to the central ZOLLER tool database, we have been able to optimize our inventory and enjoy significant savings.”





# Keep a Handle on Your Tool Storage

## TMS Tool Management Solutions Software from ZOLLER

You can now enjoy full transparency on tool circulation and storage: You can control access rights, display storage locations graphically with just a click, print out inventory overviews and trigger orders. Materials stored in the wrong location will be a thing of the past, as will machine down-times due to missing tools.

In a nutshell: Enjoy higher profits with Smart Cabinets in conjunction with TMS Tool Management Solutions!

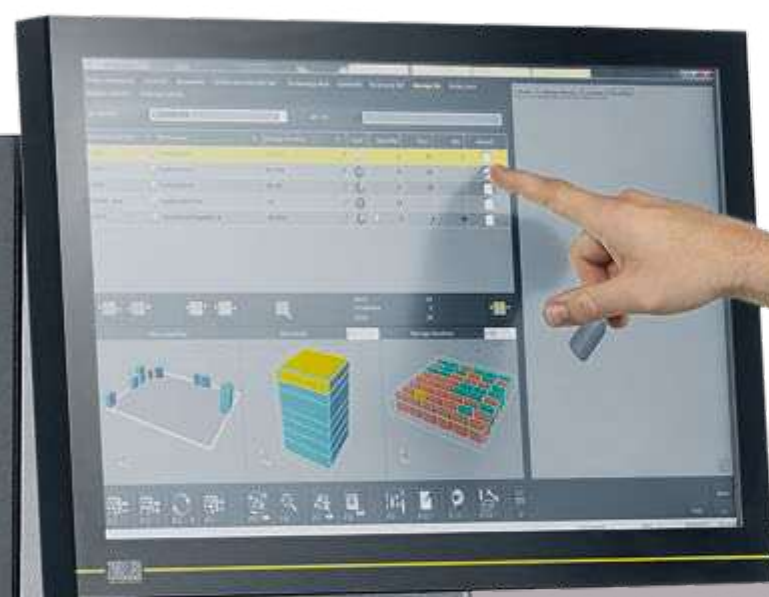

### Storage Location Management

For a fast overview of storage locations, circulation and inventory. Unique: You can display your storage area in 3D and assign virtual storage locations to different items via drag and drop.

### »quickPick« Warehouse Management

Ideal for quickly booking and removing items. With the pared down software interface, you can achieve your goal in just a few clicks.



### Equipment Management

Manage equipment efficiently in addition to your tools – including image information and set-up instructions saved with the set up sheet.

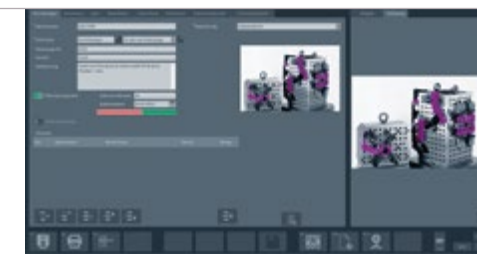

### Measuring Material Management

Better control of measuring and testing materials with set up sheet management – inspection schedules can be defined and calibration intervals monitored, while test reports are output with clear graphics.



### Article Statistics

This makes tool usage more transparent and avoids under-utilized tool potential: Convenient analysis of tool usage with "hit/flop lists" allows you to identify areas where optimization is needed and save money.



### NC Program Management

NC programs offer simple organization: Import, export and edit - quickly and easily. Versions can be compared and the desired version can be activated; programmer information is also available.

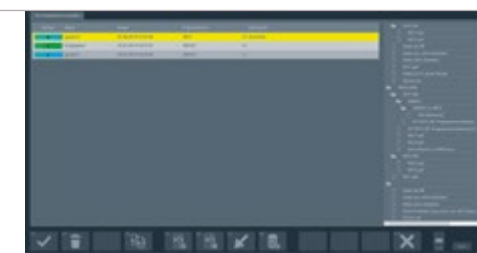

### Really Smart – Everyone's a Winner with the Consignment Warehouse

An advantage to tool manufacturers and production companies alike: the »toolOrganizer« in combination with TMS Tool Management Solutions as a consignment warehouse.

- Production companies always have the tools they need, and only pay for the ones they actually remove.
- Tool suppliers guarantee a reliable supply for the customer - a reporting service informs them of customer stock levels.



toolOrganizer



# First-Class Right down the Line

## ZOLLER Services Across the Entire Product Life Cycle

By purchasing a Smart Cabinet, you have made a long-term investment. Our service department helps ensure maximum availability for your storage solution. Anyone who chooses ZOLLER has chosen not only outstanding products, but competent partners to stand by them at any time – throughout the entire life cycle of their ZOLLER products.



### Well Advised

What are your requirements? Whether you choose a »toolOrganizer«, »keeper«, »toolStation«, »tool-Tower« or »autoLock«: From initial idea to development of a storage solution precisely adapted to meet your requirements, to commissioning – we stand by you at all times with our comprehensive expertise.

### Custom Planning

Thanks to a diverse range of customization options, you will receive products that precisely conform to your needs. This includes considering how to best spatially integrate your cabinets into your production. But there's one thing you can always rely on: You will receive detailed and practical planning for your storage solution.

### Transparent Offers

After the planning process comes the offer – a completely transparent price without hidden costs. This gives you the best possible security in your planning and your investment. We also offer alternative financing options – ask us for more information.

### Quick Delivery

Have you made your decision? Then nothing should stand in the way of your new storage solution. That's why we get your Smart Cabinets on the road as quickly as possible, securely shipped direct to you.

### Professional Implementation

To ensure you can utilize your storage solution to its fullest potential, our trained personnel provide professional support for initial operations. They also take over training of your employees. We know that competent technicians who can work independently are the basis for your success.

### Always Here for You

Do you need our support? After installation is complete, we will stand by your side with advising and consultation. You can always count on our repair and maintenance services and our quick reaction times.

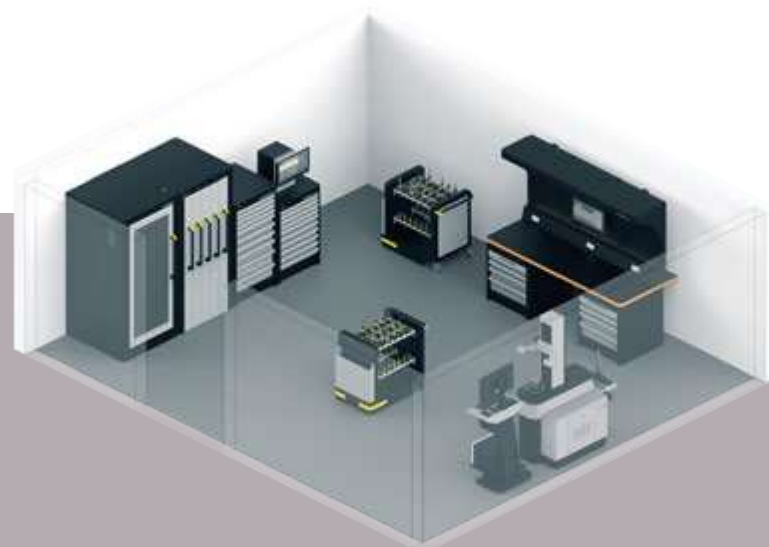

We will provide you a 3D storage plan, so you can see how your equipment will look in the space. Arrangements can be revised quickly and corrected on the layout until everything perfectly matches your needs.

# At Home in Germany – around the World for You

ZOLLER quality is “made in Germany” –  
and there for you, anywhere in the world.

Our company has its own locations and branches  
at 85 sites in 62 countries guaranteeing we are  
close to customers and can provide first-class,  
personal customer advising in local markets.

- Parent company
- Headquarters
- Branch office
- Representative

## GERMANY

### HEADQUARTERS

E. ZOLLER GmbH & Co. KG  
Einstell- und Messgeräte  
Gottlieb-Daimler-Straße 19  
D-74385 Pleidelsheim  
Tel: +49 7144 8970-0  
Fax: +49 7144 8970-70191  
post@zoller.info | www.zoller.info

### ZOLLER NORTH

E. ZOLLER GmbH & Co. KG  
Service- und Vertriebszentrum  
D-30179 Hannover

### ZOLLER EAST

E. ZOLLER GmbH & Co. KG  
Service- und Vertriebszentrum  
D-04158 Leipzig

### ZOLLER WEST

E. ZOLLER GmbH & Co. KG  
Service- und Vertriebszentrum  
D-40764 Langenfeld

## EUROPE

### AUSTRIA

ZOLLER Austria GmbH  
A-4910 Ried im Innkreis  
office@zoller-a.at | www.zoller-a.at

### SWITZERLAND

ZOLLER Schweiz GmbH  
CH-9016 St. Gallen  
info@zoller-ch.com | www.zoller-ch.com

### FRANCE

ZOLLER France  
F-67380 Lingolsheim  
info@zoller.fr | www.zoller.fr

### SPAIN + PORTUGAL

ZOLLER Ibérica S.L.  
E-08006 Barcelona  
correo@zoller.info | www.zoller.info

### TURKEY

Zoller Ölçüm Teknolojileri San.ve Tic. Ltd. Sti.  
TR-16120 Nilüfer / Bursa  
info@zoller-tr.com | www.zoller-tr.com

### RUSSIA

LLC ZOLLER Russia  
RU-111123 Moscow, Russia  
info@zoller-ru.com | www.zoller-ru.com

### ISRAEL

ZOLLER Israel GmbH  
Ramat Yishay 3009500  
info@zoller-il.com | www.zoller.info

### POLAND

ZOLLER Polska Sp. z o.o.  
60-104 Poznan  
biuro@zoller-a.at | www.zoller.net.pl

### SLOVAKIA + CZECH REPUBLIC

ZOLLER CZECH s.r.o.  
602 02 Brno  
suchna@zoller.cz | www.zoller.cz

## AMERICA

### USA

ZOLLER Inc.  
North American Headquarters  
USA-48108 Ann Arbor, MI  
sales@zoller-usa.com | www.zoller-usa.com

### CANADA

ZOLLER Inc. Pacific  
USA-90503 Torrance, CA  
sales@zoller-usa.com | www.zoller-usa.com

ZOLLER Canada Inc.  
CAN-LSN 864 Mississauga, ON  
sales@zoller-canada.com | www.zoller-canada.com

### MEXICO

ZOLLER Tecnologías S de R.L. de C.V.  
MEX-C.P. 76030 San Angel Querétaro  
sales@zoller-mexico.com | www.zoller-mexico.com

### BRASIL

ZOLLER do Brasil  
BRA-CEP 13284-198 Nova Vinhedo,  
Vinhedo – São Paulo  
comercial@zoller-br.com | www.zoller-br.com

## ASIA

### INDIA

ZOLLER India Private Ltd.  
IN-Pune 411019 Maharashtra, India  
info@zoller-in.com | www.zoller-in.com

### CHINA

ZOLLER Shanghai, Ltd.  
Asia Pacific Regional Headquarter  
RC-201108 Shanghai  
info@zoller-cn.com | www.zoller-cn.com

### ZOLLER Asia Pacific, Ltd.

RC-Kowloon, Hongkong  
info@zoller-cn.com | www.zoller-cn.com

### JAPAN

ZOLLER Japan K. K.  
JP-564-0037 Osaka, Japan  
info@zoller-jp.com | www.zoller-jp.com

### THAILAND

ZOLLER (Thailand) Co. Ltd.  
Amphur Muang Chonburi, TH-20000 Thailand  
info@zoller-in.com | www.zoller-th.com

### INDONESIA

ZOLLER Singapore Pte. Ltd  
Indonesia Representative Office  
Tambun - 17510, Bekasi, Jawa Barat  
info@zoller-in.com | www.zoller-in.com

### SINGAPORE

ZOLLER Singapore Pte. Ltd  
SG - 199589 Singapore  
info@zoller-in.com | www.zoller.info

### MALAYSIA

ZOLLER MALAYSIA SDN. BHD.  
Malaysia Representative Office  
MY-Petaling Jaya | Selangor Darul Ehsan, Malaysia  
lau@zoller-my.com | www.zoller-in.com

### VIETNAM

ZOLLER Vietnam  
VNM-Ho Chi Minh City, Vietnam  
info@zoller-in.com | www.zoller-in.com

### KOREA

ZOLLER Korea Co., Ltd.  
KOR-15119 - Siheung-Si, Gyeonggi-Do, Südkorea  
info@zoller-kr.com | www.zoller-kr.com

## REPRESENTATIVES

Argentina, Australia, Belarus, Belgium, Bolivia, Chile,  
Colombia, Costa Rica, Croatia, Denmark, Estonia,  
Finland, Great Britain, Hungary, Iran, Ireland, Italy, Latvia,  
Lithuania, Luxembourg, Netherlands, New Zealand,  
Norway, Pakistan, Peru, Romania, Saudi Arabia,  
South Africa, South Tyrol, Sweden, Taiwan, United Arab  
Emirates, Venezuela





# ZOLLER solutions

More speed, higher quality, reliable processes –  
with ZOLLER you get more out of your production process.  
We combine hardware, software and service  
to create optimum system solutions for presetting,  
measuring, inspecting and managing tools.

Presetting & Measuring

Tool Management

Inspection & Measuring

Automation

Everything from a single source.  
Everything for your success.  
Everything with ZOLLER Solutions.

#### Headquarters in Pleidelsheim

E. Zoller GmbH & Co. KG  
Tool presetter and measuring machines  
Gottlieb-Daimler-Straße 19 | D-74385 Pleidelsheim  
Phone: +49 7144 8970-0 | Fax: +49 7144 8060-807  
post@zoller.info | www.zoller.info

#### ZOLLER North

E. Zoller GmbH & Co. KG  
Service and Sales Center  
Wohlenbergstraße 4 c | D-30179 Hannover  
Phone: +49 511 6765 57-12 | Fax: -14  
zollernord@zoller-d.com

#### ZOLLER West

E. Zoller GmbH & Co. KG  
Service and Sales Center  
Friedrich-Krupp-Straße 7 | D-40764 Langenfeld  
Phone: +49 2173 59670-90 | Fax: -81  
zollerwest@zoller-d.com

#### ZOLLER East

E. Zoller GmbH & Co. KG  
Service and Sales Center  
Fugger Business Park | Fuggerstraße 1 B | D-04158 Leipzig  
Phone: +49 341 332097-60 | Fax: -61  
zollerost@zoller-d.com

**ZOLLER**  
expect great measures