



The ZOLLER solution for tool organization

# TMS Tool Management Solutions

“ZOLLER has been developing software since the early days of personal computers”

Everything started with a commodore 64; no sooner on the market, ZOLLER tested the new technology, recognized the potential – and embarked on the first steps of software development.



Dear reader,

When we demonstrate our tool management software we are often asked about our experience. After all this concerns “software, not machines,” they say. How do we answer this question? Our experience is difficult to beat – we have been developing software since the early days of personal computers. Since then, we have been providing innovative, and pioneering solutions specifically in the area of software development.

As a current example: We are the first provider of tool management software offering the import of tool data from the cloud. This allows provision of tool data from the tool manufacturers in DIN 4000 / ISO 13399 format – exactly the form and data structure required by our customers for their individual CAM systems. This makes tedious entering of tool data by hand, and creating data structures a thing of the past.

Future-oriented solutions like these are both our passion and commitment. In the same manner that the name ZOLLER stands for quality, precision and reliability, it is also a synonym for innovation and cost effectiveness. The logical consequence is a high-performance tool management system like ZOLLER TMS Tool Management Solutions. For our customers this is a true added value. And that precisely is our endeavor – since the invention of personal of computers.

Alexander Zoller

Christoph Zoller

Eberhard Zoller



# ZOLLER TMS

Tool Management Solutions

## Contents

### ZOLLER solutions

- 02\_\_ "ZOLLER develops software since the invention of computers"
- 03\_\_ Editorial – System solutions to give you a competitive advantage

### ZOLLER TMS Tool Management Solutions

- 06\_\_ 8 good reasons for measurably more cost-efficient production
- 08\_\_ At ZOLLER you get more than you expect
- 10\_\_ Intelligent production with best perspectives – adopt existing data, download new data
- 12\_\_ Your tool data under control. Any time, any place – flexible access
- 14\_\_ Open to new ideas. Today and in the future – integrate third party systems
- 16\_\_ A system adapted for growth? Of course – expand step by step

### Packages

- 18\_\_ Primed for success right from the start – the ZOLLER software packages
- 20\_\_ Cost-efficient tool management – BRONZE Package
- 22\_\_ Efficient warehouse management – SILVER Package
- 24\_\_ Perfect tool management – GOLD Package
- 26\_\_ Tool requirements under control – in focus: machine query with ZOLLER »cetus«
- 27\_\_ Tool life under control – in focus: machine query with ZOLLER »flash«
- 28\_\_ Put an end to tool searches – in focus: inventory with ZOLLER »toolOrganizer«

### Results

- 30\_\_ The solution by ZOLLER – the people who understand tools – for a transparent process
- 32\_\_ The team for maximum efficiency – TMS Plus
- 34\_\_ References – the proof: Yes, ZOLLER can!

### We are at your service

- 36\_\_ So close, it is like us being there – service worldwide
- 37\_\_ Complex functions easy to implement – service packages
- 38\_\_ Addresses of subsidiaries and agents

# 8 good reasons for measurably more cost-efficient production

## Reducing setup times

The right tool at the right time and in the right place – always. Control-specific data output avoids entry errors on the machine and the resulting costs.

## Saving on stockroom costs

You can see which tools are used how often and only order what is really required.

## Increasing productivity

Optimized tool circulation ensures short throughput times and well utilized machines, productivity increases, manufacturing costs are lowered.

## Better organization

Planned processes with quantifiable cycle times and efficient control ensure efficient process management and lead to shorter reaction times. Independent manufacturing units can be integrated and organized.

## Finding instead of searching

You will always know which tools are available for which machines and where these are located.

## Avoid machine downtimes

All tools are always available, 24/7. Having the correct tools on the machines prevents collisions, tool breakage is avoided.

## Guarantee quality

High system availability and transparent, stable manufacturing processes guarantee highest quality.

## Exploit tool potential

Optimal cutting speeds and feed increase tool life.



**ZOLLER has the solution.**

ZOLLER TMS Tool Management Solutions ensure that the right tool is at the right place at the right time.

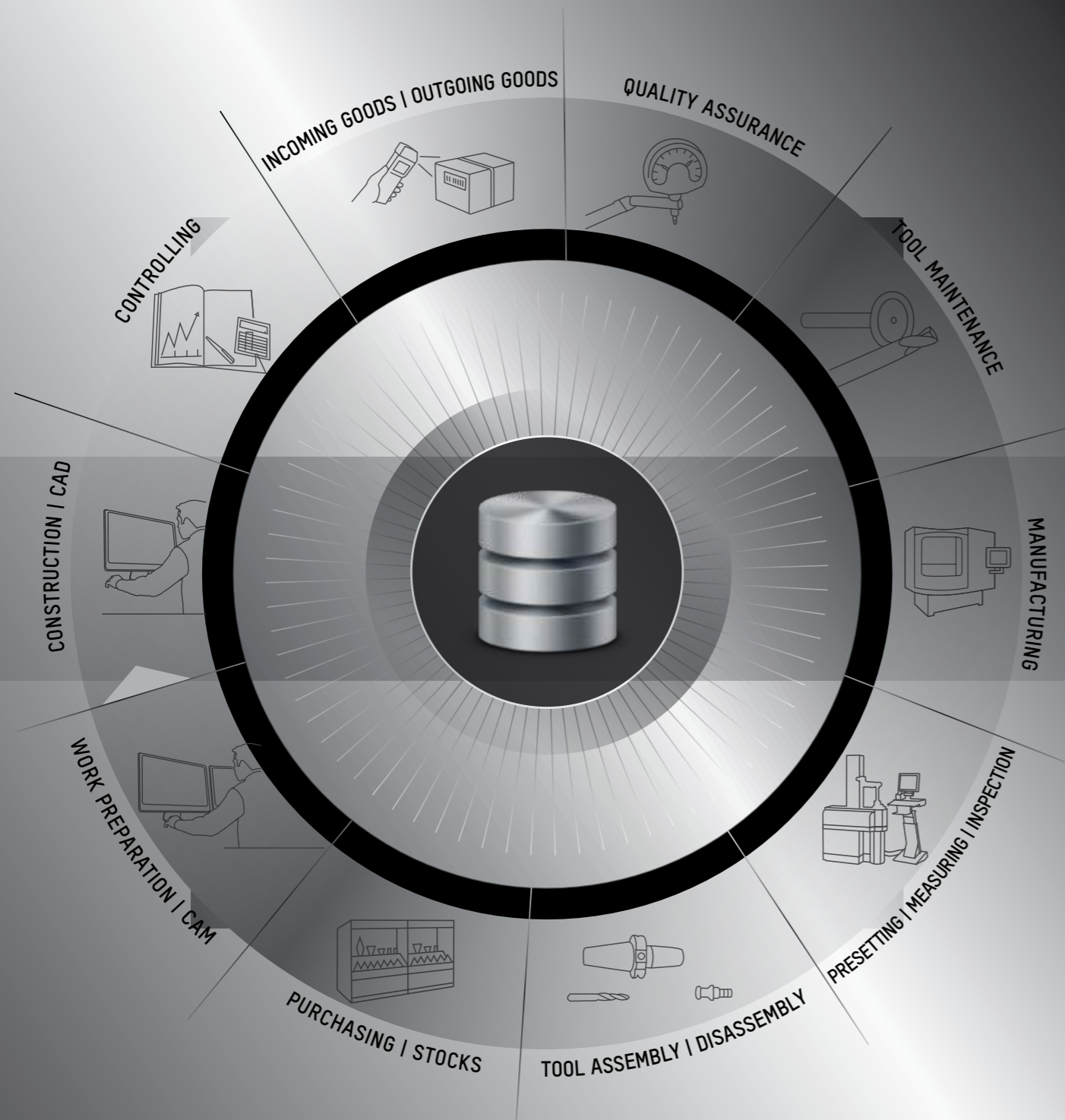

ZOLLER offers everything from a single source.  
Software, service plus tool presetters and measuring  
machines – for your individual system solution.

# At ZOLLER you get more than you expect

Many pride themselves with tool management. But who can offer you perfect integration into your overall process? Data consistency from the CAM system through to the machine? With real tool data or downloaded from the cloud, ready for programming? Who can adopt your existing data and your data structure? And then offer you fast worldwide support on top? ZOLLER can.

## z.One > ONE data base for EVERYTHING

From design to the finished part: all stations of the manufacturing process are linked via the central data base with all data: CAD/CAM department, warehouse, purchasing, machines and, of course, the ZOLLER tool presetter and measuring machine. Multiple data storage and capture is a thing of the past.



### Adopt existing data, download new data

ZOLLER TMS Tool Management Solutions can be integrated perfectly into the closed process chain. Existing data structures can be adopted, recorded data can be reused, missing data can be downloaded from the cloud.



### Flexible access

Manage your data from the comfort of your office or directly at the tool presetter and measuring machine: the user interface remains the same and the ZOLLER App or the browser-based interface give you access from any location.



### Integrate third party systems

Link existing or new CAM systems without difficulties.  
Over 20 interfaces are already available today.



### Expand step by step

The modular design lets you expand the scope of functions according to your requirements. And as ZOLLER implements new developments as standard solutions, this saves you from having update problems with special solutions. Long-term.

Adopt existing data, download new data

# Intelligent production. With best perspectives.

You can utilize existing cloud platforms with manufacturing-relevant data for your own process via the ZOLLER data base – at the push of a button. There is no simpler and more future-oriented way to optimize your production!

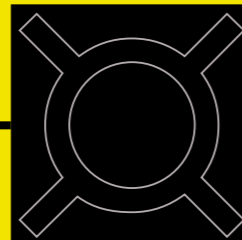

utilizing own data structure  
continued use of existing data  
maximum process reliability  
maximum productivity

Tedious manual data entry? Superfluous: all tool data provided on the cloud by leading tool manufacturers and catalogs are only a mouse click away with the ZOLLER TMS Tool Management Solutions! Simply download the desired data and create your own data base. Direct data linking is possible via the ZOLLER data base. You can communicate with all CAM systems in your company immediately. The data is available immediately. For example, you can create realistic 3D tool models and provide your CAM system with complete tool data in 2D and 3D as well as article characteristics. These data are also available for simulation systems.



NOVO

CIM AACHEN  
CIMBOJACE Software

EWS

### Strong partners for a positive outlook

Machining Cloud, ToolsUnited, NOVO, Hoffmann and EWS – ZOLLER can import the tool data of these manufacturers at a mouse click. Depending on the system, it is possible to import entire assemblies and not only individual components.



Flexible access

# Your tool data under control. Any time, any place.

Reliable access to your tool data, easy and organized from anywhere via smartphone or tablet, from the office, any terminal with web browser and, of course, from your ZOLLER tool presetter and measuring machine. Only ZOLLER can give you this flexibility!

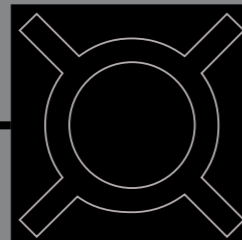

flexible access per iPhone/iPad  
from the tool presetter and measuring machine  
from any work station with web browser  
no elaborate installation necessary

With the ZOLLER App you have full control of your tool data – quite literally: using your smartphone or tablet, you can access master data, graphs, drawings, article characteristics and stock information from any location. You can search for tools or scan them in the App, make stock logs, or capture tool life and reasons for change. You can also gain information from your tool lists via setting sheets via the App. This gives you all the information necessary for processing your parts.

**Intuitive operation, clear representation**

The desired information is found quickly with the ZOLLER App, provided in a compact manner and supported visually with graphs and images. Operating the App is intuitive and easy. Just as you are used to from your smartphone or tablet.



**Easy, familiar operation**

Of course you can also manage your tools from the comfort of your office or directly at the tool presetter and measuring machine. And as ZOLLER is a single source supplier, the operating interfaces of the tool management system and the tool presetter and measuring machine are absolutely identical: the operator feels at home immediately and work becomes even more efficient.



Integrate third party systems

# Open to new ideas. Today and in the future.

ZOLLER TMS Tool Management Solutions can integrate all conventional third party systems without problems, from the ERP and CAM system via cabinet and lift systems through to the machines. Tool identification systems via chip or data matrix code and orientation towards future requirements in terms of Industry 4.0 have today already become a reality at ZOLLER.

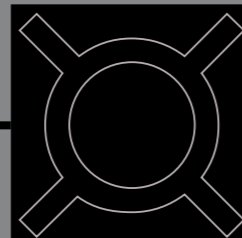
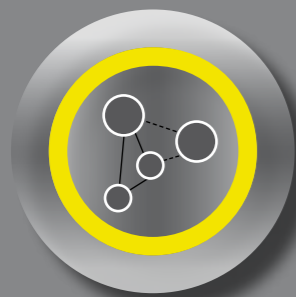

- all conventional CAM systems
- cabinet and lift systems
- machine controls
- new developments for new systems

The trouble-free integration of third party systems has a long tradition at ZOLLER – since tool presetters and measuring machines are fitted with electronics. And as ZOLLER also has a tradition in focusing on the cost-effectiveness of the entire manufacturing process, this extended open access for all other systems involved in the manufacturing process is only logical – and consistently future-oriented. No matter which new systems or new machines will be developed in the future – ZOLLER will be able to integrate them.

**1 \_ Linking to cabinet and lift systems**

Among others, ZOLLER offers links to Hänel, Kardex, Bedrunka and Hirth, Gühring, Iscar, Klingseisen, Kennametal, Storetec and Modula.

**2\_ Linking to tool identification systems**

You can use all state-of-the-art tool identification systems, whether RFID or barcodes.

**3 \_ Interfaces to machines and controls**

Tool data can be outputted control-specific on USB sticks, serial interfaces (online) and into the network.

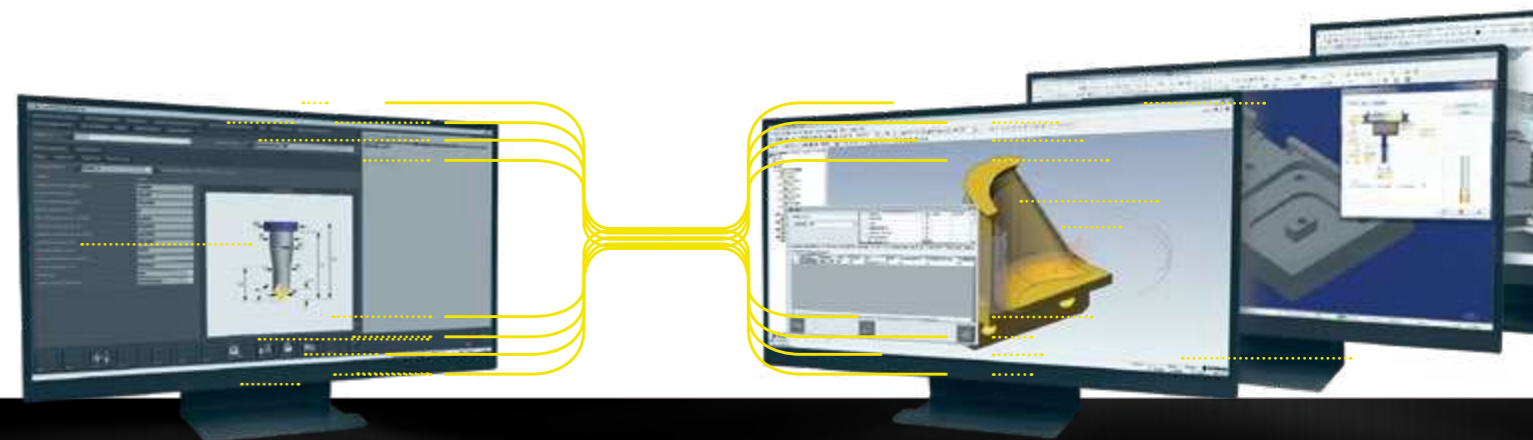
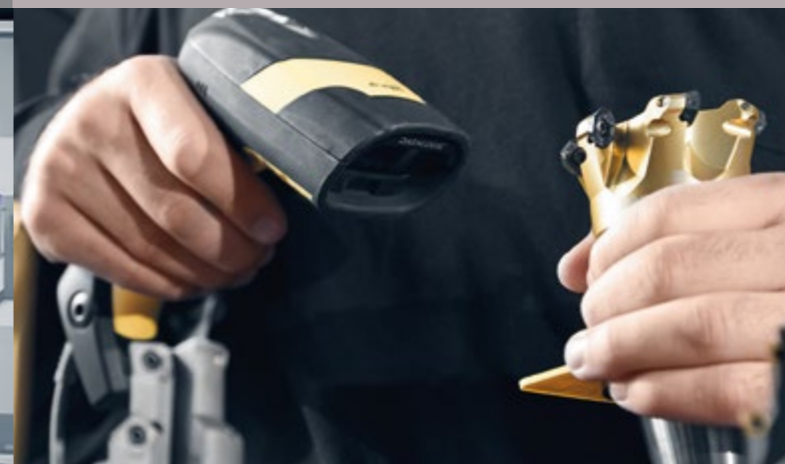

**CAM interfaces with user-friendly interfaces**

Everything as usual: ZOLLER software provides the user with his familiar CAM tool structure. This makes the CAM interfaces extremely user-friendly: changeover times become obsolete, work processes are accelerated.

**Over 100 output formats to machines**

To provide control-specific data output from the ZOLLER tool presetter and measuring machine to the machine, the ZOLLER format generator includes a library with over 100 output formats for all major manufacturers of machines and controls. These are available immediately to all users – unique from ZOLLER.



Expand step by step

# A system adapted for growth? Of course!

The three software packages, BRONZE, SILVER and GOLD, offer you everything you need for your manufacturing process. Modular design, freely expandable – and easy to implement. A software you can build on.

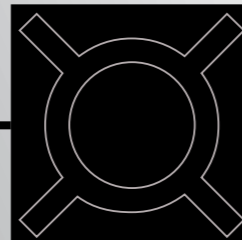
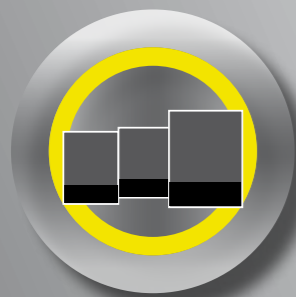

modular design can  
be expanded as required  
easy to implement

ZOLLER TMS Tool Management Solutions grow with your needs – step by step. Start with the BRONZE Package and make your tool management considerably more cost-effective. Convinced? Then continue with warehouse management and the SILVER Package. Efficient warehouse management saves money. Full cost control is provided by the GOLD Package and perfect tool organization. At ZOLLER adapting also means that our packages are always updated: functions are upgraded and new requirements are met with new functions which become standards integrated in our updates. This ensures that you will always be state-of-the-art in the future.

## Step by step toward an optimal manufacturing process

- Step 1: cost-efficient tool management**  
Minimum search times through maximum transparency
- Step 2: efficient warehouse management**  
Reduced storage costs through optimal stock control.
- Step 3: perfect manufacturing organization**  
Full cost control, transparency and efficiency.

**ZOLLER »toolOrganizer«**  
Allow us to present: the ideal stand-alone introduction to your tool management. The ZOLLER »toolOrganizer« including software package ensures that your tools are stored with reliable access, can be found at any time and are available at a single click.

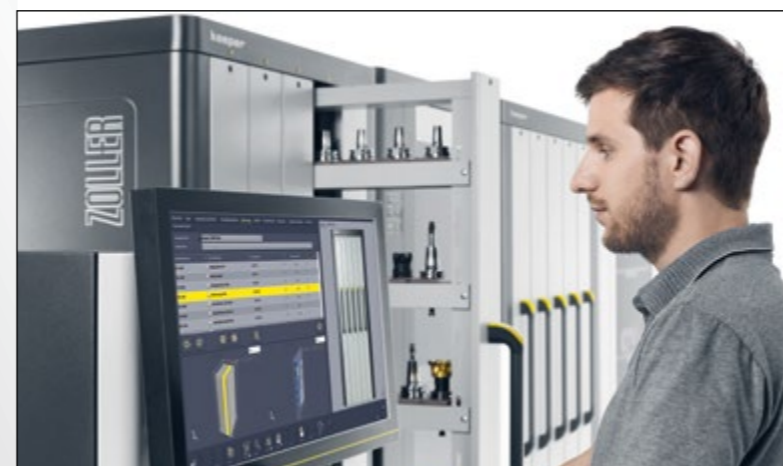

The ZOLLER software packages

# Primed for success right from the start

With its three powerful packages, ZOLLER TMS Tool Management Solutions offer you everything you need for your entire tool management. Simply choose what suits you best:

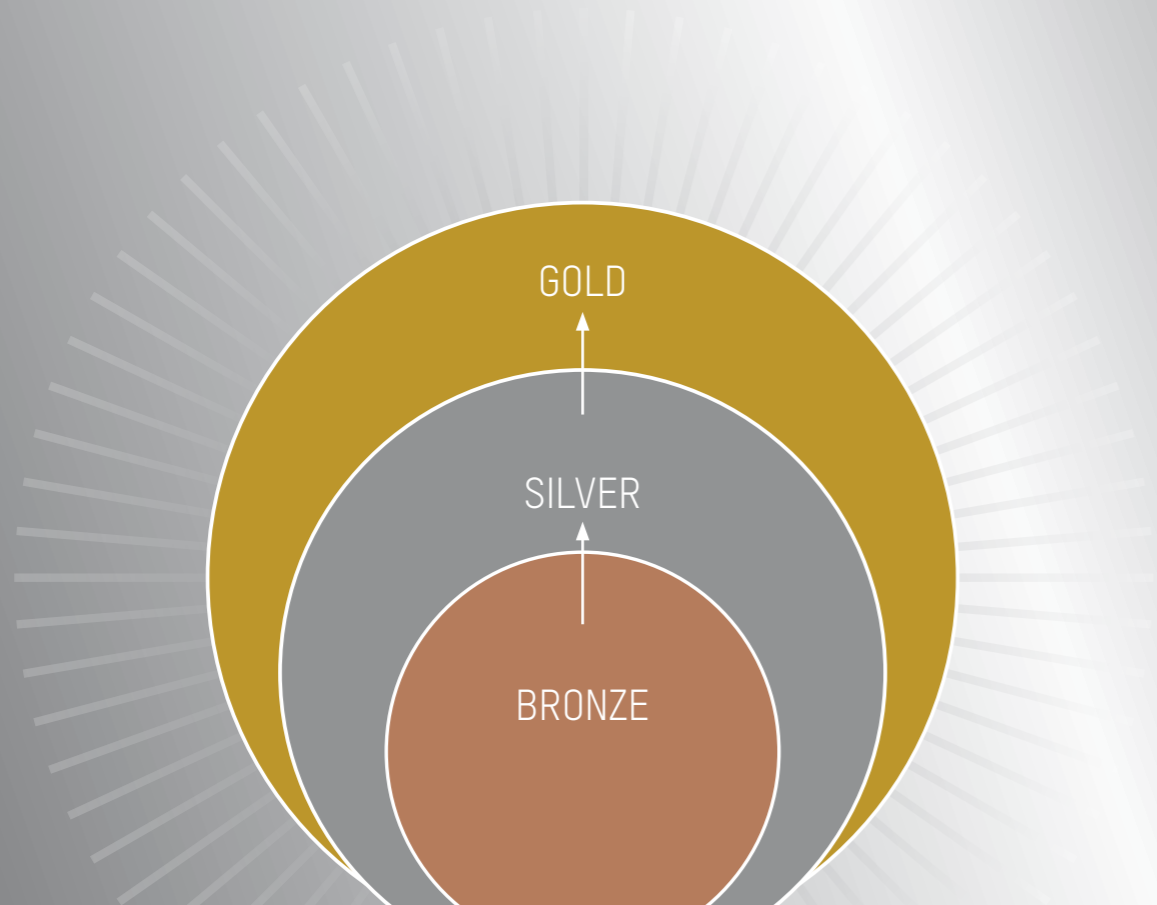

We at ZOLLER  
understand tools.  
Convince yourself!

**GOLD**  
SILVER Package plus:

- Incoming goods/Outgoing goods
- Controlling
- Purchasing
- Tool maintenance



**SILVER**  
BRONZE Package plus:

- Quality assurance
- Warehousing



**BRONZE**

- Design, CAD
- Production planning, CAM
- Tool assembly/Disassembly
- Presetting, Measuring, Inspection
- Production

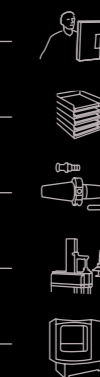

Drawing → Product



With the BRONZE Package you have your tools under control: all relevant data are saved at a single location, from the drawing to the finished product. The SILVER Package extends the management functions to your warehouse and the GOLD Package optimizes your entire tool management. For greater efficiency across the board.

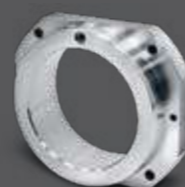

## BRONZE Package

# Cost-efficient tool management

The scope of the ZOLLER BRONZE Package functions lets you organize your complete tools, individual components and accessories cost-effectively. All tools and tool components are captured, recorded and managed at a single location, duplicate and multiple data storage is avoided.

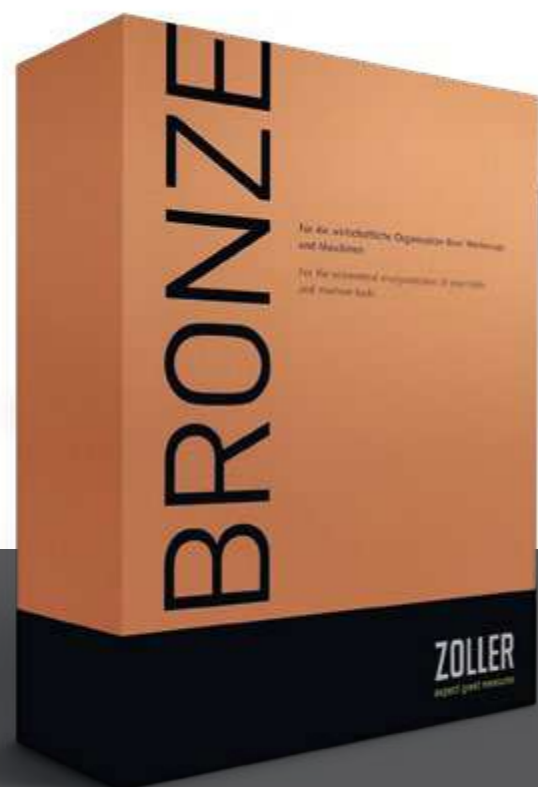

### Management of tool data

Ideal software module for small and medium-sized businesses as introduction to meaningful tool management.

### Technological data and article characteristics

Data provision for individual components and complete tools for further processing in the ZOLLER TMS Tool Management Solutions as well as in third party systems, i.e. CAM.

### Article characteristic bar according to DIN 4000 / ISO 13399

Standard-compliant definition of individual components and complete tools using the complete DIN 4000 / ISO 13399 article characteristics structure.

### Import options cloud

Utilization of existing cloud platforms of tool manufacturers to provide manufacturing-relevant data for your own process.

### Data import/export XML

Platform-independent import and export of tools, individual components and setting sheets, accessories, machine data and more.

### ZOLLER Webservice

Time and cost savings: with its universal, open data base access, third party systems access the tool information in the ZOLLER tool data base in a standardized and easy manner.

### Excel read-in filter

Easy import of your article data from Excel.

### Data input/output including format generator

Control-specific output of data on a USB stick, serial interface (online), network or DNC.

### USB camera

Easy and fast capture of tool images for visualization in tool management.

### Integration of measuring machine

Use of all functions also on the ZOLLER tool presetter and measuring machine.

Incl. 1 Floating licence and 1 Viewer licence

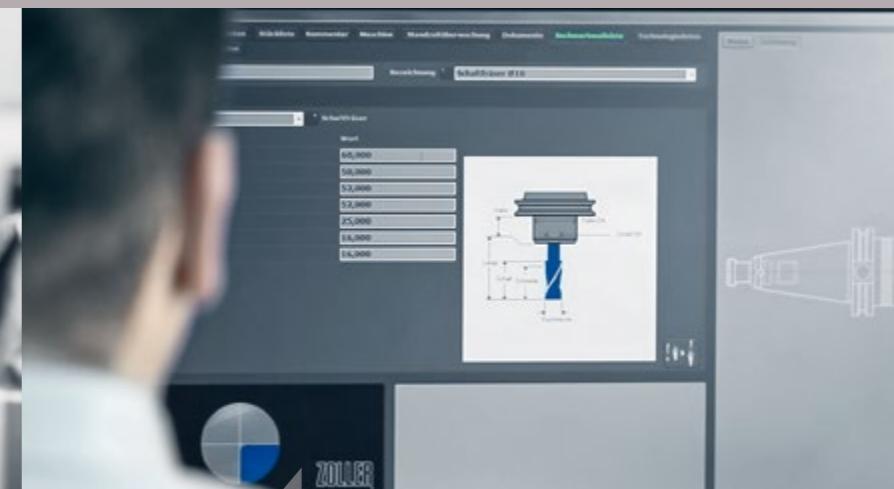

"With ZOLLER TMS Tool Management Solutions I can find my familiar user interface 1:1. This also applies to the same tool classes as in my CAM system – this makes my work considerably easier!"



### Easy creation of realistic tool models

With only a few inputs you can create realistic tool models, also of complex and rotationally non-symmetric tools – simply and quickly by using the novel tool generation based on DIN 4000 / ISO 13399 / DIN 4003 and the integration of a fully-fledged 3D core. To combine the models of different tool manufacturers or with the self-generated graphs, DXF or 3D models can also be imported and used for tool assembly in the ZOLLER TMS Tool Management Solutions.

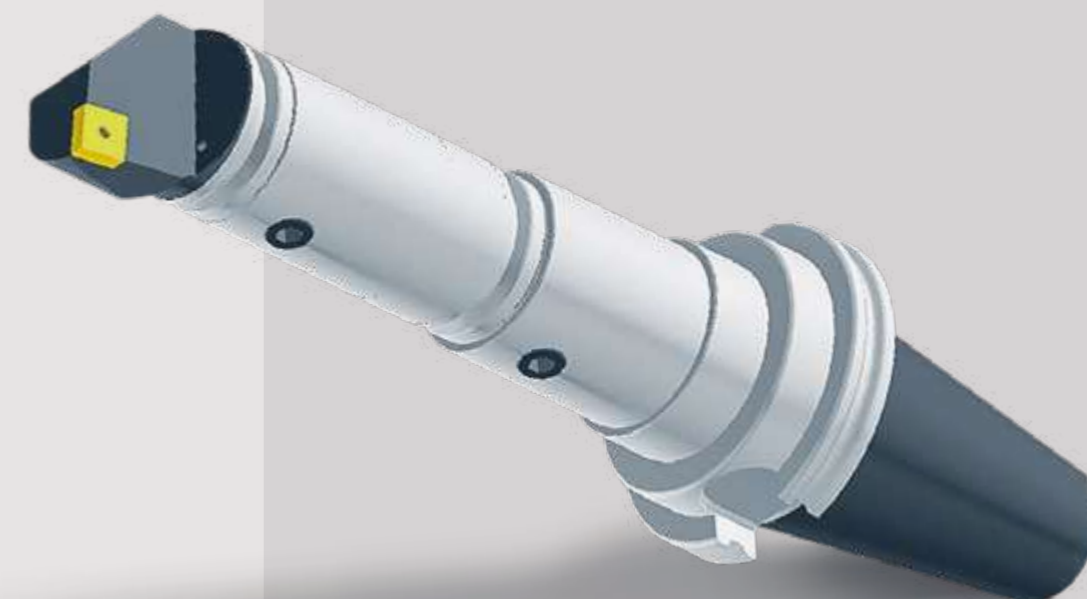

transparent organization of tool pool  
central data storage instead of duplicate data storage  
easy administration of relevant documents

## SILVER Package

## Efficient warehouse management

The SILVER Package includes the entire scope of the BRONZE Package and complements this with effective warehouse management and standardized manufacturing data management with organized tool management. It also lets you evaluate extensive inspection equipment, devices, NC programs and all stock movements with comprehensive statistics.



All modules of the BRONZE Package **plus**:

#### Administration of storage location

Convenient and up-to-date management of your complete tools, your tool components and your accessories, together with a quick overview on storage location, circulation and current stocks.

#### Warehouse module »quickPick«

The warehouse interface with reduced functions allows fast logging in and out of articles with only a few clicks.

#### Management of measuring devices

Better control of the measuring and inspection equipment through management according to the setting sheet, monitoring of calibration intervals and inspection protocols with meaningful graphs.

#### Fixture management

Up-to-date management of your fixtures according to the setting sheet, including visual information and set-up instructions.

#### NC program management

Simple management of your NC programs according to the setting sheet, also various versions, including saved clamping diagrams, tool drawings and volume models.

#### Item statistics, stock recording

For the identification of „Top tools“ and „Flop tools“: the item statistics based on the stock logs give you a meaningful analysis of tool consumption. The tool information in the ZOLLER tool data base can also be accessed in a standardized and easy manner via third party systems.

#### KROMI interface

Less personnel, no duplicated data recording: this interface enables the 1:1, automatic and direct import of DIN 4000 / ISO 13399 master tool data.

#### Interface »toolOrganizer«

Discover the advantages of the ZOLLER »toolOrganizer« on pages 28/29.



“The ZOLLER TMS stock management immediately tells you which tools are stored in which drawers.”

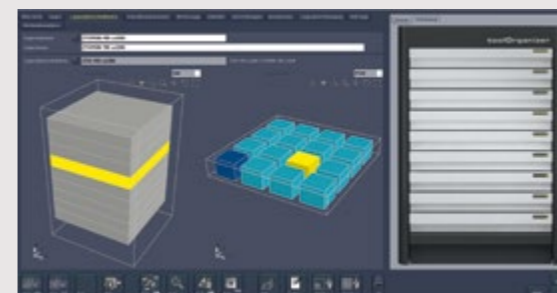

#### Managing storage locations

Provide your production cost-effectively around the clock with the required complete tools, components and accessories: the virtual 3D kit lets you replicate your warehouse quickly in 3D and you can assign your articles to a virtual storage location. This gives you a quick overview on storage location, circulation and the current stocks of each recorded item and a stock report at the push of a button.

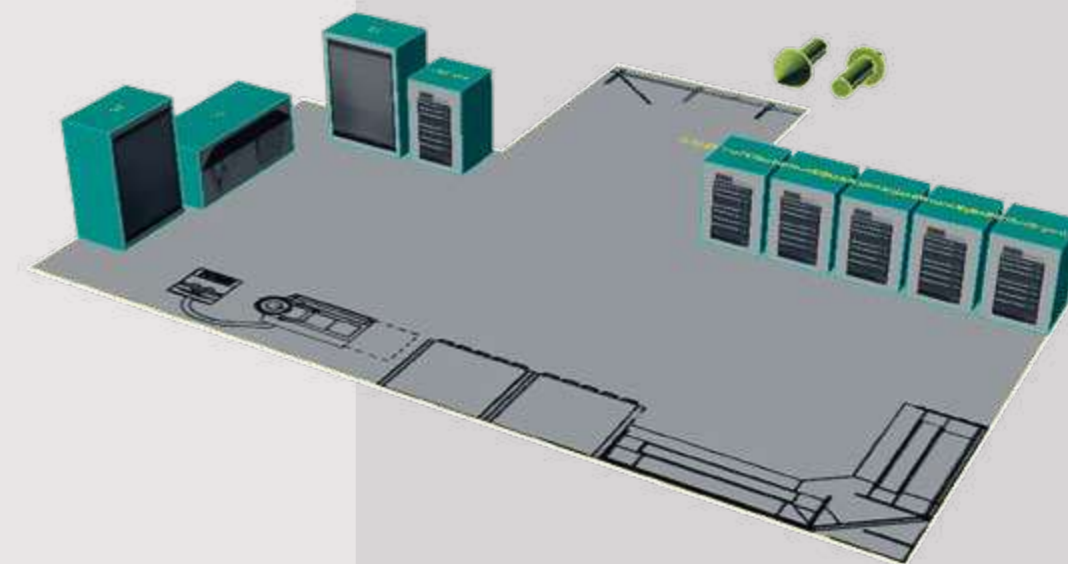

integrated flow control of all tools  
optimal stock control  
tool monitoring for quality control

## GOLD Package

# Perfect tool management

The ZOLLER GOLD Package lets you maximize the efficiency of your tool management. You have full cost control and transparency of the process chain. Your tools can be located at any time. Control and evaluate your costs with statistics on individual tools and orders, to always be in a position to take the right decisions.



All modules of the BRONZE and SILVER Packages **plus**:

#### Ordering system

Optimize your ordering processes and only order what you really require – process-safe on the basis of minimum order levels or automatic purchase requests.

#### Re-grinding cycle

For the transparent consistent management of re-grinding or maintenance processes.

#### Tool life management

For optimal utilization of machine run times, from tool monitoring to process-specific configuration. With statistic function to give an overview tool life and reasons for change of individual tool stages.

#### Tool requirement optimization »cetus«

For the process-safe and economical provision of tools for your production: saves costs as the machines can be run with smaller tool magazines and tool requirements are reduced.

#### Measurement statistics

For the graphic evaluation and management of measurements and data sets for quality control, analysis purposes, documentation, proof and/or measurement control/management.

#### Parts management

The module for parts management is used for the systematic management of individual parts and assemblies and for documentation of the tools required including setting sheets.

## In focus: ZOLLER "CPP" software module

# Production optimization with "Cost Per Part"

With this module, a simple click gives you an overview on the service life of your tools to date, the reasons for change and the costs per assembly.

CPP analysis enables a comparison of budgeted and actual costs per part and the analysis of service life and reasons for change allows conclusions on the quality of the tools and processes. The ZOLLER CPP module determines two separate key figures: the budgeted CPP are compared with the actual CPP. The calculation comprises the definitions of service life and quantity of tools as well as the purchasing prices, the number and costs of the re-grinding processes.

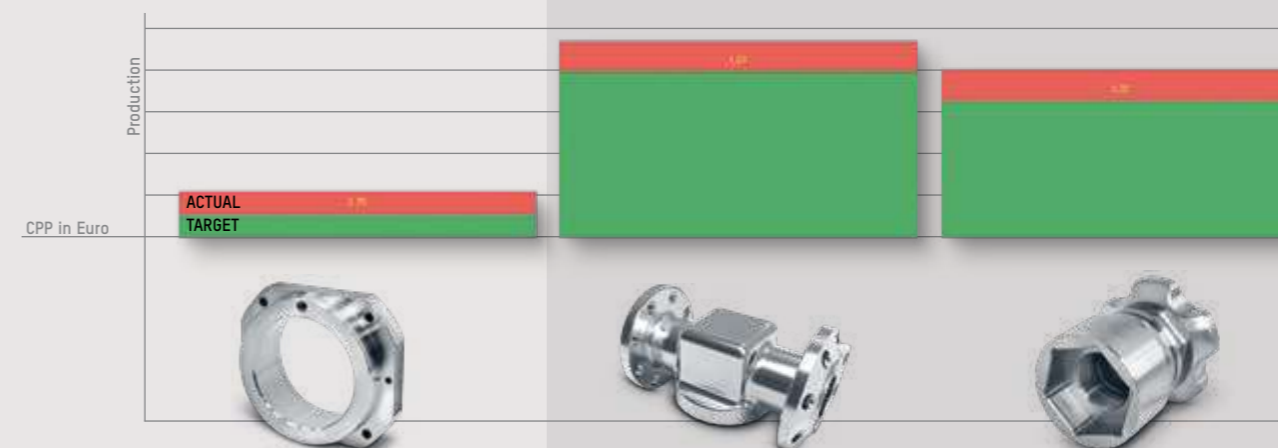
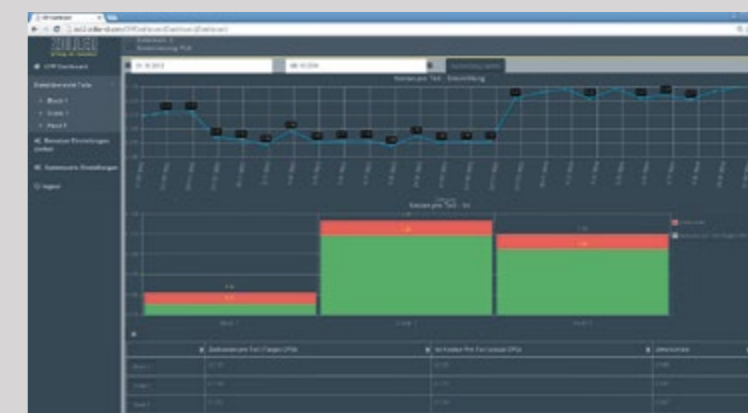

seamless organization of the tool data  
full cost control, transparency and efficiency  
smooth processes

In focus: machine query with ZOLLER »cetus«

# Tool requirements under control

The tool requirement optimization »cetus« reproduces the entire manufacturing workflow on the basis of setting sheets – the result being the process-safe and economical provision of tools for your production.

When adding a setting sheet, internal calculation or online query of the machine control calculates the net tool requirement. This gives you an instant overview as to which tools need to be set up in addition on the machine to manufacture a part. After checking with the magazine, the warehouse employee is provided with the determined tool requirement. As soon as the tools have been successfully removed from stocks, the tool information is passed directly to the presetting and measuring machine, the tools are measured and the actual data passed to the machine control system.

The result: »cetus« enables machines to run with smaller tool magazines, reduces tool requirements and lowers the costs.

With tool exchange list »cetus«

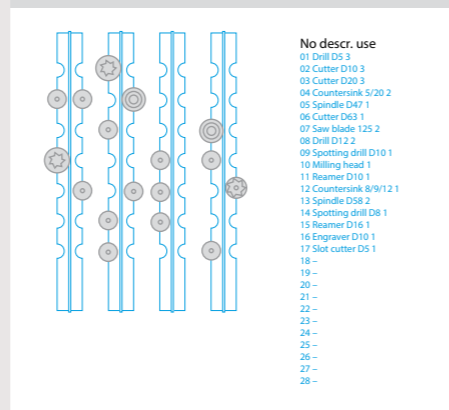

Without tool exchange list »cetus«

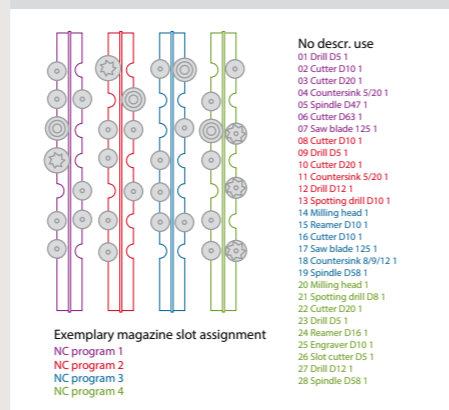

Optimized magazine assignment with the tool replacement list »cetus«. Without the differentiation list, each further item or NC program would be prepared and set up anew for all tools, although some of them are already used at the machine and are available.

easy, quick, systematic order management  
minimization of search times  
optimized magazine assignment

In focus: machine query with ZOLLER »flash«

# Tool life under control

Instant greater transparency in production processes: »flash« lets you monitor all tools used in the production process, check service life, organize the tools and change them on time. This achieves a new dimension in production control – with increases in productivity “at the push of a button”.

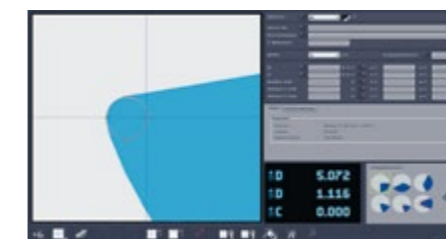

## 1\_Query of tool service life in real time

The service life of the tools is queried automatically and operator-independent for each machine. Tools whose life has expired or whose warning limit has been reached, can be released individually for recommissioning.

## 2\_Recommissioning at the push of a button

The tools released for tool preparation are compiled in a list and made available to the warehouse employee for commissioning. Release for tool presetting is given following commissioning and assembly.

## 3\_Measurement of released tools

The released tools are compiled in a list and can be preset and measured at the push of a button. Then they are released for production.

## 4\_Control-specific data output

The measured tool data are transferred control-adequate to the machines. Machine crashes due to faulty data input are eliminated.

perfect control and management of the tools  
traffic light colors display the current status  
minimum waiting times at the machine

In focus: inventory with ZOLLER »toolOrganizer«

# Put an end to tool searches

The search for complete tools, tool components or accessories can be very time-consuming – time you can save when you work with the ZOLLER »toolOrganizer«. No depositing of tools in incorrect places, no machine downtimes due to missing tools, no waste time – reliable orderliness and lowered costs.



The clearly organized warehouse interface »quickPick« can be installed on the »toolOrganizer« and allows you simple and quick stock entries.



The "small" solution for your stock keeping:

#### ZOLLER »toolOrganizer«

The ZOLLER »toolOrganizer« is available in five different versions designed to meet various applications – for example, the use of long tools or the use of several indexable insert packages. Select the version to meet your needs – and operate up to five »toolOrganizers« in series.

#### ZOLLER »toolOrganizer« software package

Manage tools, components and accessories systematically and efficiently – and find the exact location of the desired tool or component with a single click. The warehouse locations are displayed graphically in 3D, the tools with images. Stock entries are automatically passed on to the ZOLLER »toolOrganizer« via a direct link and the corresponding drawer is unlocked. Next to looking for minimum stock levels, purchasing orders can also be triggered. An analysis of tool consumption including the generation of hit-flop lists is also possible with this module.

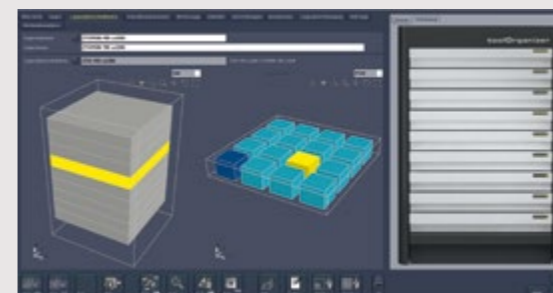

"No searching for tools anymore, less machine downtime and an overview of tool stocks at a glance – it pays to invest in orderliness – even with tools."

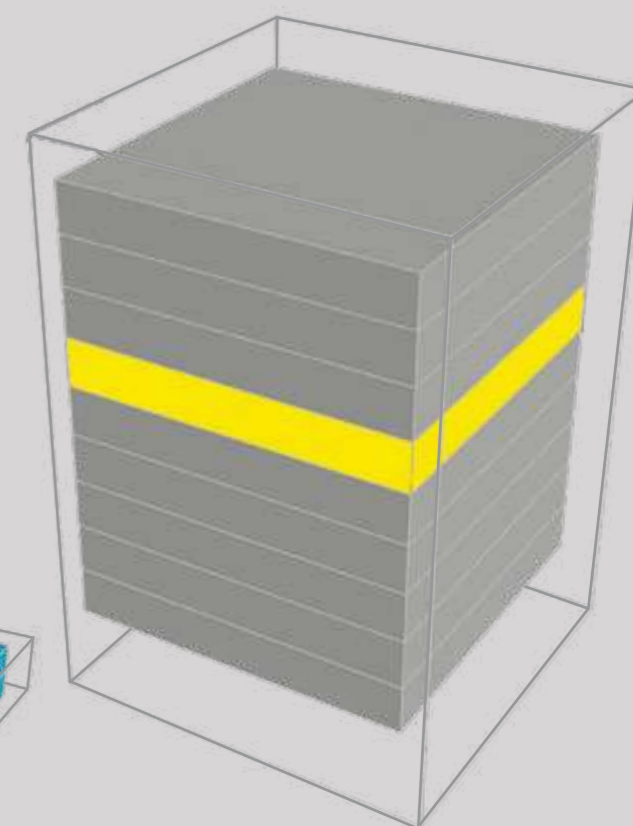
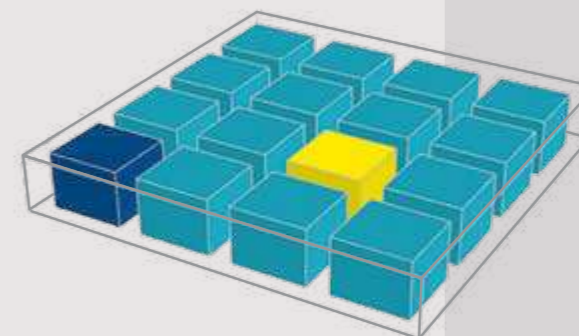

reduction of search times and "hidden stocks"  
circulation check and warehouse transparency  
manufacturing and planning safety

For a transparent process

# The solution by ZOLLER – the people who understand tools

No matter whether you manufacture small lots or in series – you can manage your tools efficiently with the ZOLLER TMS Tool Management Solutions. We accompany your tools from beginning to end – for the whole life of a tool!

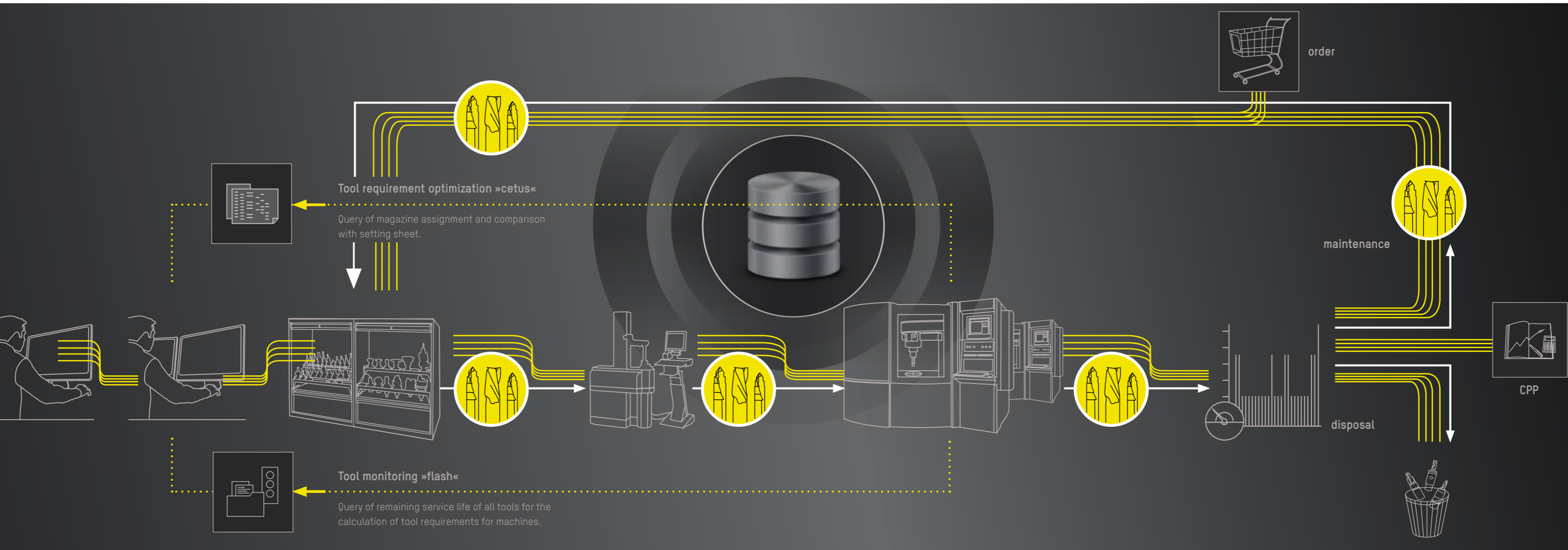

CAD   design	CAM   work preparation	Warehouse	Presetting and measuring	Production	Documenting service life and reasons for change	Maintenance, disposal or ordering	CPP   Item statistics Analysis
--------------	------------------------	-----------	--------------------------	------------	---	-----------------------------------	--------------------------------

The tool data is already available to the designer from the ZOLLER TMS data base during the design stage. Assemblies can therefore be oriented along standard tools.

The ZOLLER data base can be accessed live from the CAM system. Once all the required tools are loaded, the assembly is programmed. Then the required tools for the order are transferred to the ZOLLER TMS Tool Management Solutions in form of a setting sheet.

All the required components as well as devices and measuring equipment are booked out of the stores, whereby cabinet and lift systems can be addressed directly.

The thus assembled tools are available as order for measurement at the tool presetter and measuring machine – and correspond precisely to the specifications of CAM programming.

The data of the measured tools are transferred control-specific to the machine. Magazine assignment and service life can also be queried live from the machine for the »cetus« tool requirement optimization and the »flash« tool monitoring.

The tools returned from the machine are recorded, the remaining service life and reasons for change are documented.

The tools are reconditioned, disposed of or ordered new.

The data recorded during a tool lifecycle, for example, stock rotation, goods receiving or costs/assembly can be analyzed comprehensively.



TMS Plus

# The team for maximum efficiency

Only available from ZOLLER: the overall package with TMS Tool Management Solutions PLUS a ZOLLER tool presetter and measuring machine, services, interfaces to programming systems and much more. This powerful combination is your big PLUS: for a consistent process solution – from simple tool recording to transferring the actual data to the machine controls.

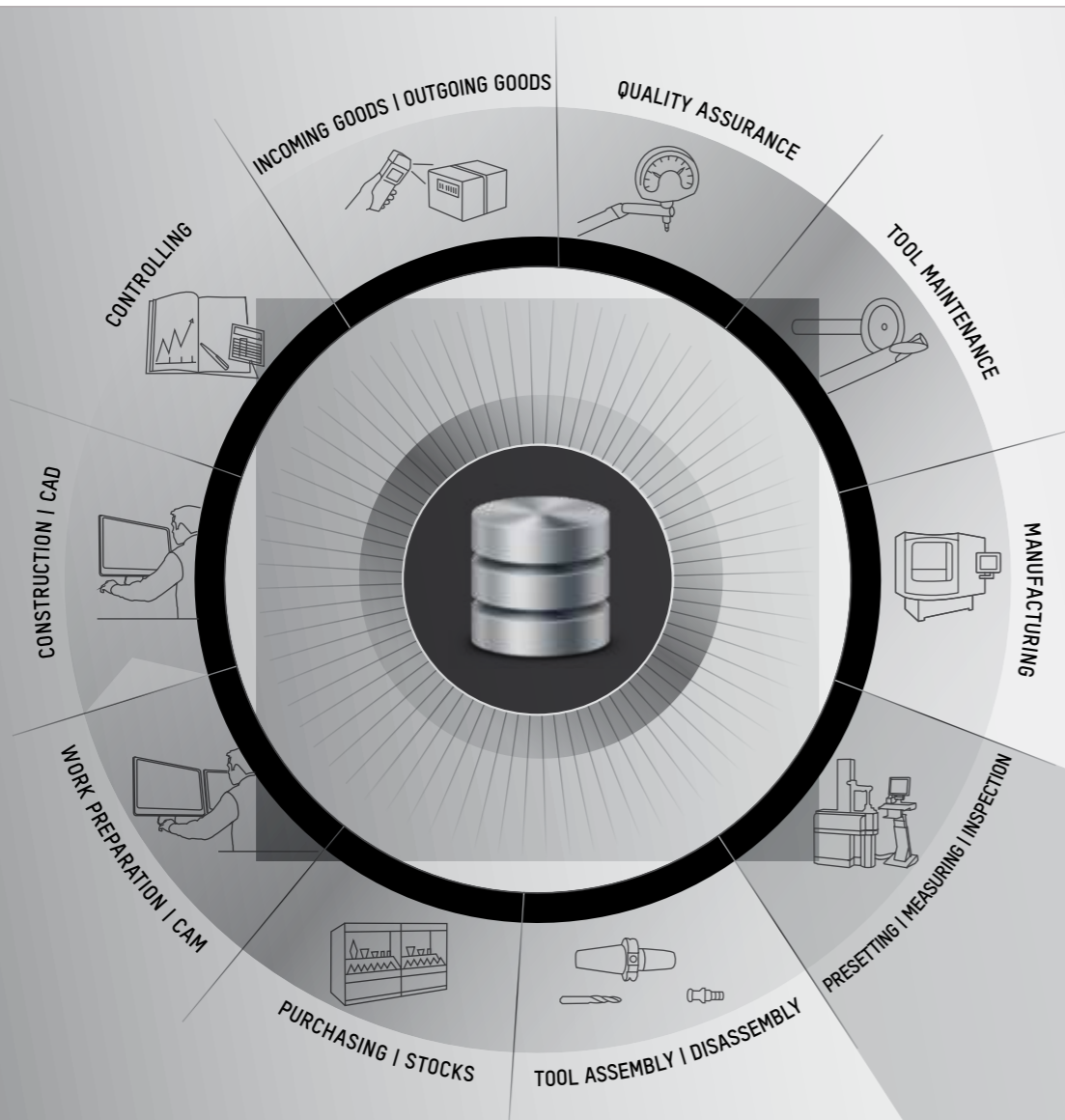

one data base  
one contact partner  
data consistency

— You only have one contact partner for your tool presetters and measuring machines, your software and the service.

— You only work with ONE data base for all modules, over the entire lifecycle of the tool.

— You are always that decisive step ahead of your competitors because ZOLLER always acts with cost-efficiency in mind.



ONE data base for EVERYTHING **z.0ne**

The proof: Yes, ZOLLER can!

## References

With ZOLLER TMS Tool Management Solutions you accelerate NC programming, improve your tool management, optimize your work efficiency... and much more. Read for yourself what our satisfied customers have to say:

Claus O. Nielsen (Jydsk Aluminium Industri) in Herning, Denmark

»We save considerable amounts of time with the ZOLLER Tool Management, as everyone now knows exactly where the tools and single components are. [...] The price-performance ratio for the introduction of a tool management system is good value.«



Dave Morley (ZOLLER Inc.) and Michael Meyer (Bosch Rexroth) in Fountain Inn, USA

»I was very pleased to add my contribution [...] to the optimization of work efficiency at Bosch Rexroth.«



Dietmar Dürr (Managing Director GDS Präzisionszerspanungs-GmbH) in Offerdingen

»Today, this allows us process-safer, easier and faster throughput – [...] simply by optimizing the periphery.«



Philipp Mahr and Markus Röttgen (ZOLLER) with Simon Schumacher, Elmar Schweizer, Bernd Gruber (CERATIZIT)

»The ZOLLER TMS stock management immediately tells you which tools are stored in which drawers.«



Rüdiger Hof and Sergej Ponomarenko (Bombardier Transportation) in Netphen

»The ZOLLER TMS Tool Management Solutions save on tool costs, accelerate NC programming and shorten feed times.«



Frank Pieterwas and Jan Horn of Lufthansa Technik with Julian Lüdecke from ZOLLER and Ulrich Rienks from Camtech (from left to right)

“We wanted the ZOLLER data base as leading system. If a new tool is to be set up, then it should be entered in the ZOLLER Tool Management data base, so that the name is correct, as well as the description and the T-number. Thus, once entered it is used by all employees in a standardized manner throughout the entire process and can be found consistently.”

Jan Horn, Lufthansa Technik

Service worldwide

# So close, it is like us being there

Our globally established TMS specialists will support you quickly and with competence in case of questions and problems – either by remote assistance or in person. Worldwide in 49 countries.

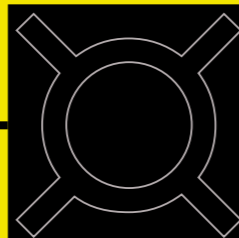

fast, competent diagnosis  
short downtimes  
reduced service costs

Your benefits due to excellent ZOLLER service:

- Global service network of highly qualified specialists
- Fast, streamlined support from TMS specialists
- Prompt diagnosis and initiation of effective measures via remote support per online connection
- Reduction of downtimes
- Cost reduction in case of service



Service packages

# Complex functions easy to implement

Many people believe that the new start of a complex system is time-consuming and difficult. We disagree! In order to exploit the full potential of the ZOLLER TMS Tool Management Solutions with a trained team and an initial data base, you or your key users require only 8 to a maximum of 15 days – depending on the software package. An investment which pays for itself every day through optimized productivity and immense savings in time.

1. GETTING STARTED	2. TRAINING RUN	3. INSTALLATION	4. START-UP SUPPORT	5. FINE TUNING
Initially, we discuss all the planning steps during a project day on your premises, for example, the time schedule, the tasks and responsibilities for installation.	Then we train the efficient handling of the software with your key users. Our modern training centers offer the best framework conditions in order to learn about all the functions and be able to apply them. Training is conducted with your own master data, warehouse information etc., so that you can transfer them straight away to your data base.	Installation is conducted by a ZOLLER application technician on site: he installs the system consisting of data base and clients on your server. At the same time you appoint an administrator for your company.	Everything is now ready for you to start. We assist you with your first application steps on site: we would be pleased to support you in handling the software and generating data.	Use in practice will most likely raise a few questions. This is why your ZOLLER contact will provide you with answers for one or two months following installation and support you as required.

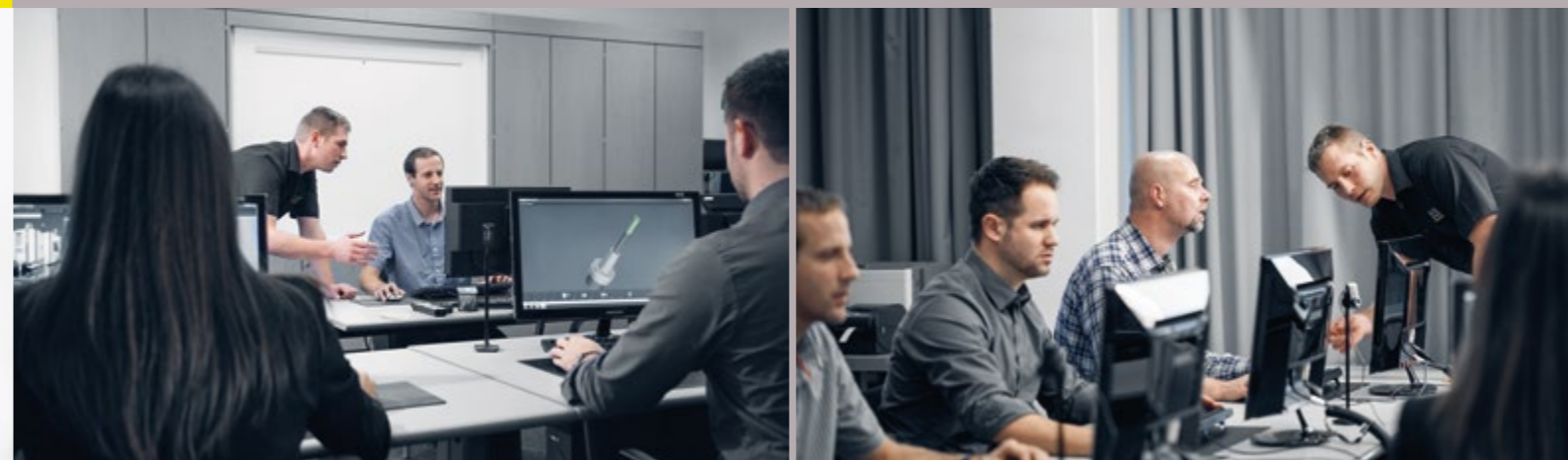

Service &amp; Data

# At Home in Germany – around the World for You

ZOLLER quality is “made in Germany” –  
and there for you, anywhere in the world.

Our company has its own locations and branches  
at 85 sites in 62 countries guaranteeing we are  
close to customers and can provide first-class,  
personal customer advising in local markets.

- Parent company
- Headquarters
- Branch office
- Representative

## GERMANY

### HEADQUARTERS

E. ZOLLER GmbH & Co. KG  
Einstell- und Messgeräte  
Gottlieb-Daimler-Straße 19  
D-74385 Pleidelsheim  
Tel: +49 7144 8970-0  
Fax: +49 7144 8970-70191  
post@zoller.info | www.zoller.info

### ZOLLER NORTH

E. ZOLLER GmbH & Co. KG  
Service- und Vertriebszentrum  
D-30179 Hannover

### ZOLLER EAST

E. ZOLLER GmbH & Co. KG  
Service- und Vertriebszentrum  
D-04158 Leipzig

### ZOLLER WEST

E. ZOLLER GmbH & Co. KG  
Service- und Vertriebszentrum  
D-40764 Langenfeld

## EUROPE

### AUSTRIA

ZOLLER Austria GmbH  
A-4910 Ried im Innkreis  
office@zoller-a.at | www.zoller-a.at

### SWITZERLAND

ZOLLER Schweiz GmbH  
CH-9016 St. Gallen  
info@zoller-ch.com | www.zoller-ch.com

### FRANCE

ZOLLER France  
F-67380 Lingolsheim  
info@zoller.fr | www.zoller.fr

### SPAIN + PORTUGAL

ZOLLER Ibérica S.L.  
E-08006 Barcelona  
correo@zoller.info | www.zoller.info

### TURKEY

Zoller Ölçüm Teknolojileri San.ve Tic. Ltd. Sti.  
TR-16120 Nilüfer / Bursa  
info@zoller-tr.com | www.zoller-tr.com

### RUSSIA

LLC ZOLLER Russia  
RU-111123 Moscow, Russia  
info@zoller-ru.com | www.zoller-ru.com

### ISRAEL

ZOLLER Israel GmbH  
Ramat Yishay 3009500  
info@zoller-il.com | www.zoller.info

### POLAND

ZOLLER Polska Sp. z o.o.  
60-104 Poznan  
biuro@zoller-a.at | www.zoller.net.pl

### SLOVAKIA + CZECH REPUBLIC

ZOLLER CZECH s.r.o.  
602 02 Brno  
suchna@zoller.cz | www.zoller.cz

## AMERICA

### USA

ZOLLER Inc.  
North American Headquarters  
USA-48108 Ann Arbor, MI  
sales@zoller-usa.com | www.zoller-usa.com

### CANADA

ZOLLER Inc. Pacific  
USA-90503 Torrance, CA  
sales@zoller-usa.com | www.zoller-usa.com

ZOLLER Canada Inc.  
CAN-LSN 864 Mississauga, ON  
sales@zoller-canada.com | www.zoller-canada.com

### MEXICO

ZOLLER Tecnologías S de R.L. de C.V.  
MEX-C.P. 76030 San Angel Querétaro  
sales@zoller-mexico.com | www.zoller-mexico.com

### BRASIL

ZOLLER do Brasil  
BRA-CEP 13284-198 Nova Vinhedo,  
Vinhedo – São Paulo  
comercial@zoller-br.com | www.zoller-br.com

## ASIA

### INDIA

ZOLLER India Private Ltd.  
IN-Pune 411019 Maharashtra, India  
info@zoller-in.com | www.zoller-in.com

### CHINA

ZOLLER Shanghai, Ltd.  
Asia Pacific Regional Headquarter  
RC-201108 Shanghai  
info@zoller-cn.com | www.zoller-cn.com

### ZOLLER Asia Pacific, Ltd.

RC-Kowloon, Hongkong  
info@zoller-cn.com | www.zoller-cn.com

### JAPAN

ZOLLER Japan K. K.  
JP-564-0037 Osaka, Japan  
info@zoller-jp.com | www.zoller-jp.com

### THAILAND

ZOLLER (Thailand) Co. Ltd.  
Amphur Muang Chonburi, TH-20000 Thailand  
info@zoller-in.com | www.zoller-th.com

### INDONESIA

ZOLLER Singapore Pte. Ltd  
Indonesia Representative Office  
Tambun - 17510, Bekasi, Jawa Barat  
info@zoller-in.com | www.zoller-in.com

### SINGAPORE

ZOLLER Singapore Pte. Ltd  
SG - 199589 Singapore  
info@zoller-in.com | www.zoller.info

### MALAYSIA

ZOLLER MALAYSIA SDN. BHD.  
Malaysia Representative Office  
MY-Petaling Jaya | Selangor Darul Ehsan, Malaysia  
lau@zoller-my.com | www.zoller-in.com

### VIETNAM

ZOLLER Vietnam  
VNM-Ho Chi Minh City, Vietnam  
info@zoller-in.com | www.zoller-in.com

### KOREA

ZOLLER Korea Co., Ltd.  
KOR-15119 - Siheung-Si, Gyeonggi-Do, Südkorea  
info@zoller-kr.com | www.zoller-kr.com

## REPRESENTATIVES

Argentina, Australia, Belarus, Belgium, Bolivia, Chile,  
Colombia, Costa Rica, Croatia, Denmark, Estonia,  
Finland, Great Britain, Hungary, Iran, Ireland, Italy, Latvia,  
Lithuania, Luxembourg, Netherlands, New Zealand,  
Norway, Pakistan, Peru, Romania, Saudi Arabia,  
South Africa, South Tyrol, Sweden, Taiwan, United Arab  
Emirates, Venezuela

ZOLLER

# solutions

PRESETTING & MEASURING

TOOL MANAGEMENT

INSPECTION & MEASURING

AUTOMATION

ZOLLER solutions stand for the comprehensive optimization of your tooling operations. We combine machines, software and services to individual system solutions to improve the quality, efficiency and productivity relating to your tools. As a customer of ZOLLER you not only benefit from our know-how as market leader in the field of tool measurement technology, but equally from our claim as a family-run business to guarantee you a sustainable competitive advantage and thus make a measurable contribution to your success.

BREITMS.03-EN.12/2021. Subject to technical modifications. The depicted machines may include options, accessories, and control variants. Delivered products have product safety labels in accordance with ISO 3864-2 or ANSI/NEMA Z535.4. Concept & design: www.abstcht.ag



[www.zoller.info](http://www.zoller.info)

E. Zoller GmbH & Co. KG | Tool presetter and measuring machines  
Gottlieb-Daimler-Straße 19 | D-74385 Pleidelsheim  
Tel: +49 7144 8970-0 | Fax: +49 7144 8060-807  
[post@zoller.info](mailto:post@zoller.info)

**ZOLLER**  
expect great measures