

ZOLLER

expect great measures

Universal Presetting and Measuring Machine
with Integrated Tool Heat Shrink System

redomatic



We Stand for Smart Progress

Multi-spindle machines and automated high volume manufacturing demand precisely set processing tools. This is the only way a tool exchange can be possible without further data transfer. This accelerates setup processes and reduces machine downtimes. ZOLLER stands for the highest precision in length-setting shrink-clamping of tools. We guarantee an accuracy of less than 10 μm – regardless of the user. This minimal tolerance can be achieved only with devices that use well-developed technology and in which components are perfectly coordinated.

Solutions from ZOLLER shrink-clamp and release quickly and safely at the highest level. Thanks to optimal interaction with the »pilot 4.0« image processing technology, the process is user-independent and can even be automated – while retaining the same level of accuracy.

Unique control concept

Highest precision

Certified safety

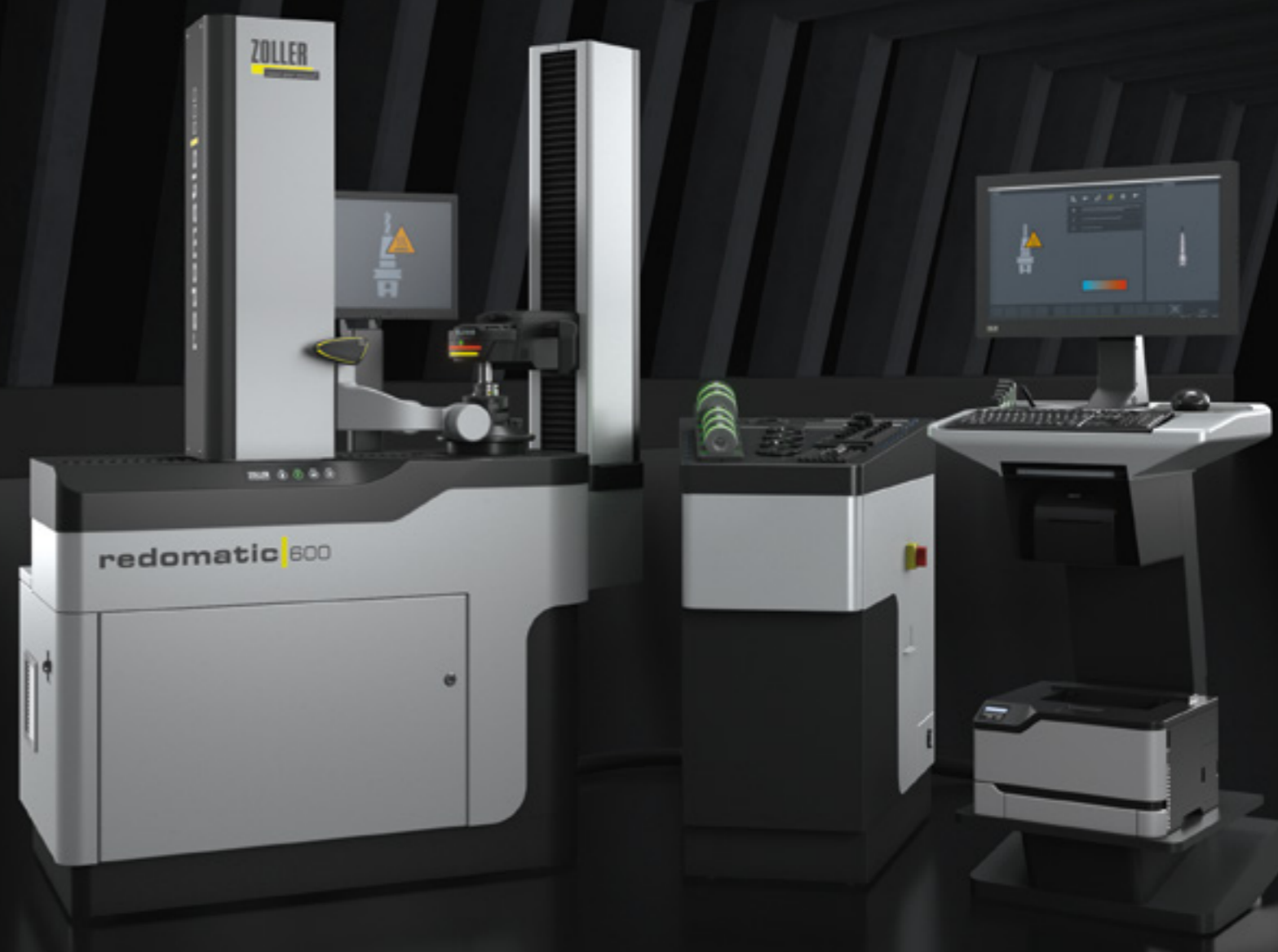

At the End, Only One Thing Counts – Outstanding Quality

With a »redomatic 400« or »redomatic 600« from ZOLLER, you can produce more effectively with your multi-spindle machines and automated high volume manufacturing. With »redomatic«, you can be sure that the tool lengths are always set correctly. The shrink-clamping process developed by ZOLLER using the »masterPiece« adjusting adapter is both quick and simple.

The perfect interaction between mechanical, pneumatic, electronic, and software components, as well as consistent user guidance and automatic measurement sequences guarantee the highest level of process reliability.



»redomatic 400«



»redomatic 600«

Compact Top Class

»redomatic 400« is the optimal system for shrink-clamping and measuring standard tools. The ZOLLER presetting and measuring machine with integrated ZOLLER shrink-clamping technology, the carrier unit for ergonomic storage of shrinking accessories, and the »pilot 4.0« image processing software offers optimal conditions for reducing the space needed.

Intelligent induction coil with automatic »varOct« shielding system – with automatic diameter adjustment up to a shank diameter of max. 32 mm for optimal heat output in every situation. The heating process is monitored continuously. The internal diameter of the »varOct« is set quickly to the required diameter through an automated CNC controlled process. Thanks to the maximum internal diameter of 45.8 mm, tools with larger cutting diameters can also be simply clamped and unclamped.

»pcs« high-precision spindle – adapter tool post for different tool holder interfaces are clamped with a changeover accuracy of 1 µm for user-independent and power-operated tool clamping.

»asza« – the automatic length setting system in the Z-axis for shrink-clamping precisely to less than 10 µm.

Shrinking length monitoring – for reliable and controlled shrink-clamping of tools with monitoring of the minimum engagement length.



Flue gas suction device – reliably removes flue gases from the user's work area. The established flue gas suction device above the induction coil was expanded with integrated suction inside the coil housing. This allows flue gases to be suctioned directly where they are produced.

Measuring machine control »pilot 4.0« with 24" display – the control system consisting of panel PC, »pilot 4.0« and 24" TFT color display takes over all processing tasks for adjusting, measuring and shrinking and ensures safe and easy operation. The monitor can be adjusted in height and tilt position, ensuring maximum comfort when using the software. The »cockpit« offers space for a keyboard and mouse, as well as shelves for label and laser printers, scanners, and tools like a hex wrench.

Cooling bells in various sizes – for direct tool cooling. Heat is dissipated quickly, accelerating the cooling process. Five cooling bells – for standard shrink-clamping chucks, from D 6 mm to D 32 mm, ensure fast, consistent cooling thanks to their intelligent design and integrated contact cooling. Your shrink-clamping chucks are protected and true run-out accuracy is maintained.

Carrier unit – for holding the shrink-clamping electronics, cooling bells, mounting rings, adjusting rods and the ZOLLER »masterPiece« adjusting adapter. The display of the »sls« shrink guide system allows quick selection of the required accessories.



»redomatic 400« TÜV and UL/CSA approved

The »redomatic 400« induction system is certified according to international IEC/EN 61010-1 and cNRTLus standard.

Proven and certified safety.

High Performance Interaction

The »redomatic 600« is the high-end solution for automated measurement, adjustment, and shrink-clamping. Additional features allow for a highly variable range of tools as well as the usage of much larger and heavier tools. Thanks to the CNC controlled axes and automatically adjustable coil, the process can be fully automated. This additionally increases the process reliability.

»eQ« (ergonomic & quick) one-hand control handle – with one hand, the optic carrier can be moved quickly, simultaneously in Z and X, and easily to the correct position. In addition, further functions from »pilot 4.0« can be integrated into the additional button of the »eQ«.

»asza« – the automatic length setting system in the Z-axis for shrink-clamping precisely to less than 10 µm.

Shrinking length monitoring – for reliable and controlled shrink-clamping of tools with monitoring of minimum engagement length.

»ace« high-precision spindle – high-precision spindle system with clamping behavior similar to a machine spindle, guarantees holding and clamping of tools exact to the µm. The universal tool holder adapter exchange system allows for adaptation to almost any tool holder system.



»redomatic 600« TÜV and UL/CSA approved

The »redomatic 600« induction system is certified according to international IEC/EN 61010-1 and cNRTLus standard.

Proven and certified safety.

Flue gas suction device – reliably removes flue gases from the user's work area. The established and patented flue gas suction device above the induction coil was expanded by integrated suction inside the coil housing. This allows flue gases to be suctioned directly where they are produced.

Intelligent induction coil with automatic »varOct« shielding system – with automatic diameter adjustment up to a shank diameter of max. 32 mm for optimal heat output in every situation. The heating process is monitored continuously. With the help of a grid, the inner diameter of the »varOct« can be adjusted to the required diameter quickly and through an automated process. Thanks to the maximum internal diameter of 45.8 mm, tools with larger cutting diameters can also be simply clamped and unclamped. Also optionally available with a quick-change interface from 14 kVA to 22 kVA.

Measuring machine control »pilot 4.0« with 24" display – the control system consisting of IPC, »pilot 4.0« and 24" TFT color display takes over all processing tasks for adjusting, measuring and shrinking and ensures safe and easy operation. The monitor can be adjusted in height and tilt position, ensuring maximum comfort when using the software. The »cockpit« offers space for a keyboard and mouse, as well as shelves for label and laser printers, scanners, and tools like a hex wrench.

Carrier unit – for holding the shrink-clamping electronics, cooling bells, mounting rings, adjusting rods and the ZOLLER »masterPiece« adjusting adapter. The »sls« display in the software allows for quick selection of the required accessories.

»sls« shrink guide system – »pilot 4.0« guides users quickly and reliably through the shrink-clamping process with the help of exactly specified job steps in the software.

Innovative cooling bells with »coolbyLight« user guidance – for a safe and simple guided cooling process using the LED color system. Alternatively, the design with standard cooling bells can also be selected for the »redomatic 600«.

Energy management software for the cooling unit – the cooling unit is switched on automatically and only as needed.



Less Energy, Maximum Profit

With the ZOLLER »redomatic«, you save time, reduce your electricity costs and protect your shrink fit tool holders, thanks to the reliable interaction of electronics, software and mechanics and a well conceived, reliable shrink process.

With ZOLLER's induction technology, you heat your shrink fit tool holders optimally. For you, this means: consistency, across the entire clamping range and only for as long as necessary. This gives you shorter heating and cooling times, shorter cycle times, protects the tool holders and increases their lifetime.

A particular advantage of »redomatic«, through which ZOLLER is making its contribution to sustainable production, is the **energy savings of up to 30%** compared to the prior model of this machine. We are especially proud of that. The heat and energy arrives exactly where you need it to safely shrink and unclamp your tools.

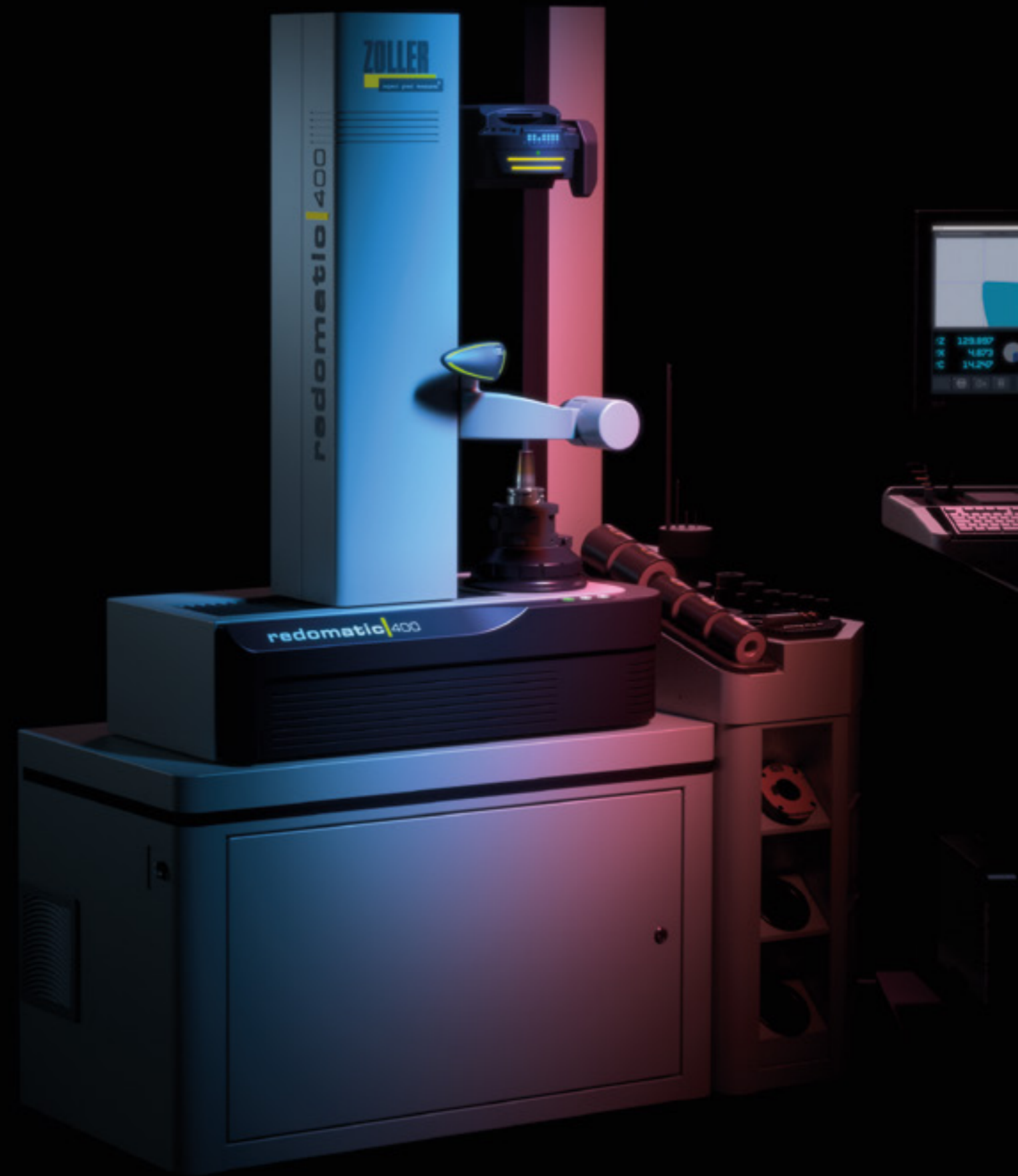
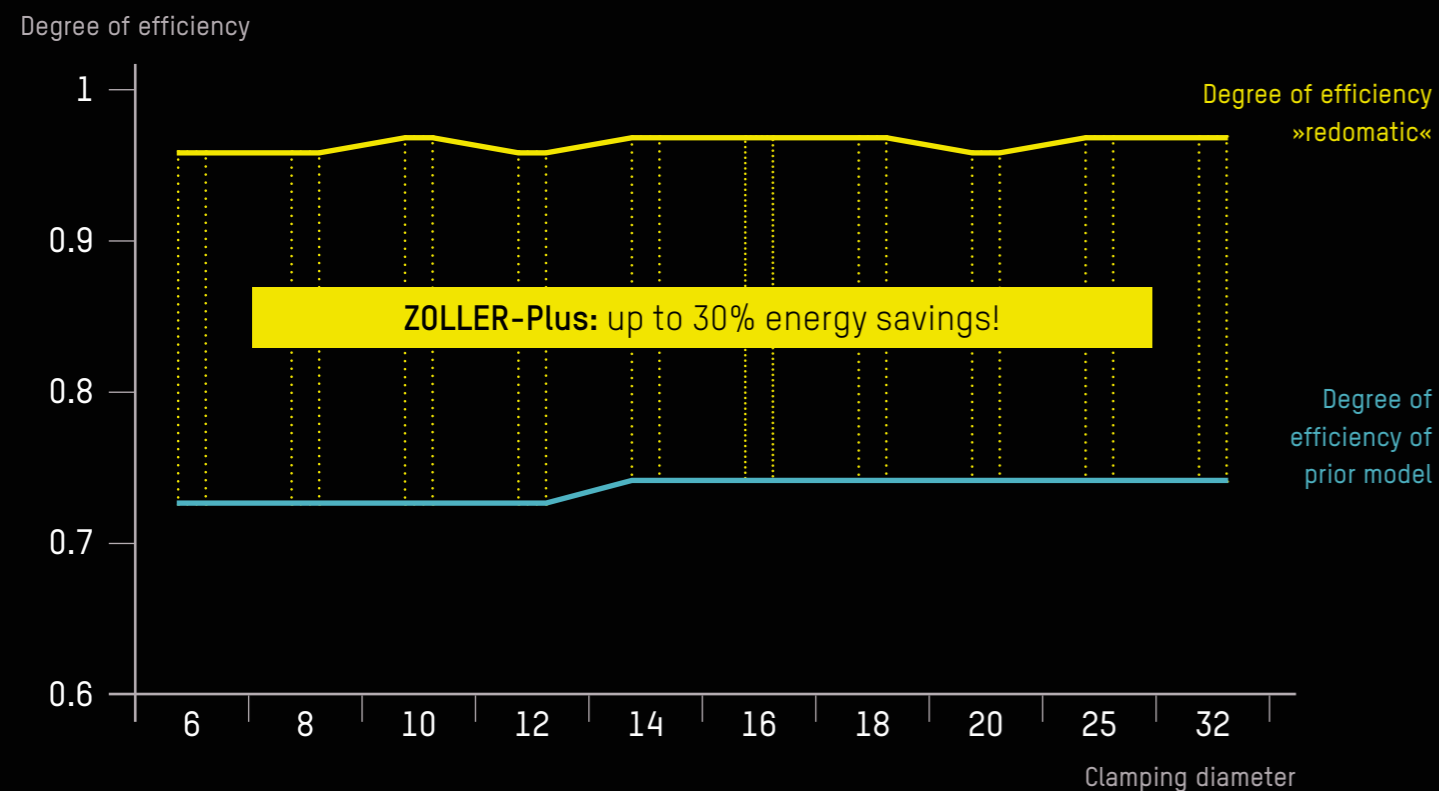

Smart Design for Maximal Efficiency

The ZOLLER induction coil, an intelligent, well-designed »redomatic« highlight. Two parallel-connected windings within the coil can be activated and controlled separately, depending on the clamping diameter and length. This feature ensures maximum operating energy into the clamping zone, accelerates the heating and cooling process, and protects your tool holders from damage during the process.

With the »var0ct« shielding system, you can look forward to even more convenience and perfect preparation for automated processes. The »var0ct« shielding system adjusts itself fully automatically to the diameter of the tool used.

Scan QR code and experience [the ZOLLER induction coil in the video!](#)



Induction coil with »var0ct« shielding system

Convenient and reliable: Position the tool, and start the shielding system or automated process at the push of a button. Step into the digital future of shrink-clamping.

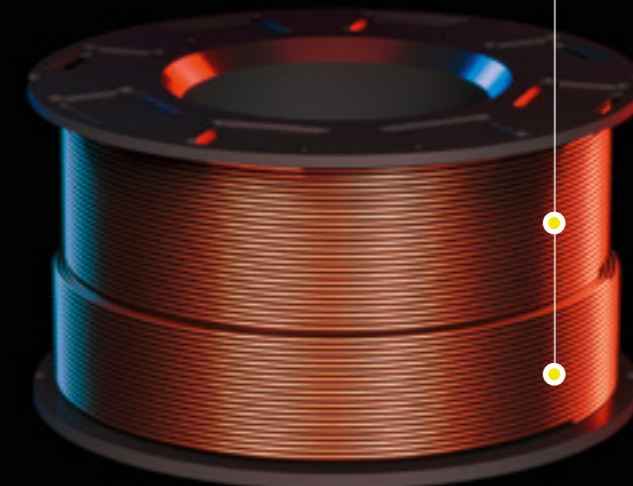
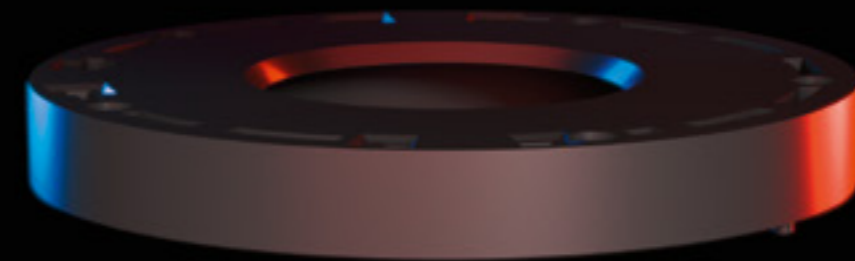

Two windings – connected in parallel and can be activated separately. Depending on the optimal setting for the particular tool holder, it is possible to heat with the upper winding only, with the lower winding only, or in an efficient and variable combination. For perfect energy input into your shrink fit tool holder, shorter heating times and a gentle shrink fit tool holder heating process.

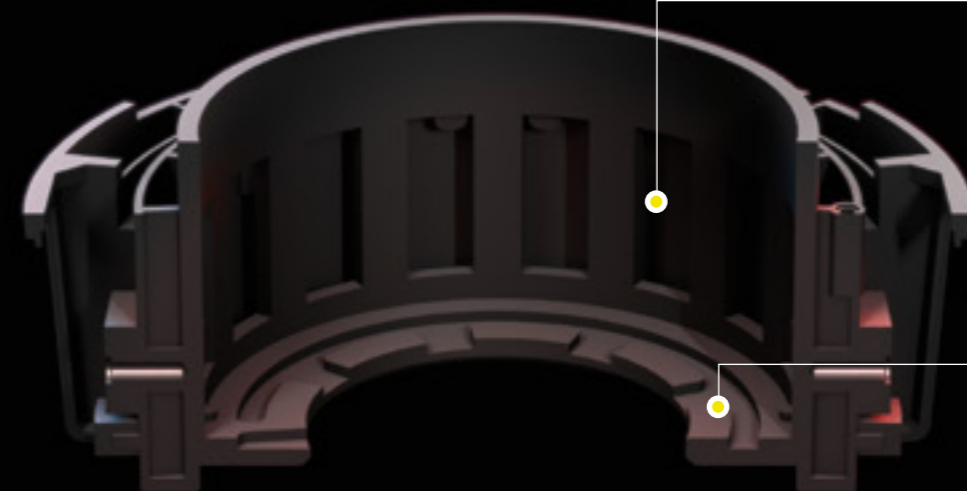

Air ducts – for optimal, passive coil cooling.

Flue gas suction device – not only extracts harmful gases directly above the coil but additionally, also directly when they are generated with the shrink fit tool holders, in the coil interior.

When Art Hits the Spot

Inspired by modern architecture and optical kinematics, ZOLLER's Research and Development department has created a masterpiece. The ZOLLER induction coil with shielding system »varOct« ensures maximum efficiency and ergonomics in the shrinking process.

The fluid, interlocking movements of the individual shielding elements allow for precise automated setting of the correct diameter of the shielding system »varOct« – for convenient and reliable shrink-clamping with maximum overlap. Thanks to an inner diameter of up to 45.8 mm, tools with larger cutting diameters can also be easily unclamped. The »shrinkbyLight« operator guidance system, consisting of the control LED for position monitoring and the status display of the windings, additionally increases process reliability.

Coil with shielding system »varOct« 14 kVA and operator guidance »shrinkbyLight«
The diameter adjustment of the »varOct« takes place either manually or in a CNC-controlled manner.



Operator guidance »shrinkbyLight« – for a safe and guided heating process.

8 Ferrite elements

Ingeniously designed. Perfectly constructed. The eight variable elements of the »varOct« shielding system glide past each other in a closed manner – a design experience.

The unique ZOLLER element, for unbeatable design and efficiency.



Status indicator LEDs – of the windings (yellow inactive, red active).

Position monitoring – indicates the correct setting (green), thereby ensuring even higher process reliability.

Reaching Your Goal Safely and Efficiently

With the ZOLLER »redomatic«, shrink-clamping tools are ready for use quickly. The »pilot 4.0« image processing software, the carrier unit, and continuous monitoring of job steps make quick and reliable work easier.

The »redomatic« technology ensures the shortest process times. Even inexperienced operators can achieve these times after just a short initial training process. All components have a fixed place on the carrier unit. The »pilot 4.0« image processing software guides users through all job steps and controls many processes fully automatically. The software lists the required components for each job step, and shows where the components are located on the carrier unit on the screen. »redomatic« is the solution for adjusting, measuring, and length-specific shrink-clamping of tools.



Carrier unit – All components for the shrink-clamping process are arranged on the carrier unit in a clear and ergonomic manner. This creates a comfortable working environment for the operators. On the »redomatic 600« model, the »sls« LED-controlled user guidance on the carrier unit additionally indicates the right components for the next job step.

»cockpit« control unit – the monitor of the measuring machine control »pilot 4.0« is adjustable in height and tilt position, ensuring maximum comfort when using the software.

»redomatic 600«



01

Insert shrink-clamping holder

02

Insert »masterPiece« adjusting adapter and tool

03

Automatic adjustment of the length setting according to the target tool length

04

Remove tool and »masterPiece« adjusting adapter

05

Induction coil moves to position, heating process starts

06

Insert tool

07

Cooling

08

Control measurement

Device shown includes options and accessories

Interaction of Hardware and Software

The »sls« heat shrink control system on the »redomatic 600« model is an excellent example of the perfect combination of hardware and software.

Measurement sequences are completely automated. If an action by the user is necessary, the »pilot 4.0« image processing software shows the exact instructions on the monitor. If components are required, these are both displayed on the monitor and highlighted on the carrier unit via illuminated LEDs. This allows users to easily achieve perfect results.

Example – Work sequence: Select and insert the right cooling bell

The »pilot 4.0« image processing software shows which cooling bell should be inserted. An LED signal on the carrier unit supports this information, allowing the operator to immediately detect which cooling bell must be taken and placed on the tool. The optionally available »coolbyLight« user guidance displays the right cooling bell and cooling process using LEDs integrated into the cooling bell.



»pilot 4.0« Always Steers Users on the Path to Success

»pilot 4.0« is the extensive and comprehensive software solution for all ZOLLER presetting and measuring machines. The intuitive, graphic user guidance guides users quickly and reliably to precise measurement results. In addition, »pilot 4.0« is so simple to operate that even complex measuring tasks can be completed immediately. At the same time, the software offers such an extensive range of functionality that there is a solution for every demand. It is no coincidence that »pilot 4.0« is considered to be the unrivaled benchmark for tool setting, measuring and testing worldwide.



Simple manual measurement with automatic cutting-edge shape identification, without generating data and specification of nominal values.

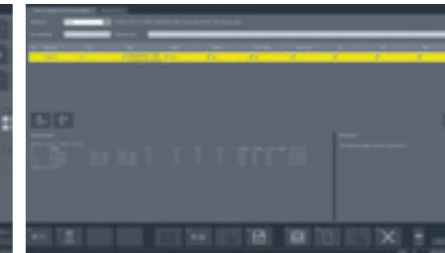

Data output in controller format for error-free transmission of the measured values to the machine tools.



»elephant« technology allows every user to measure any standard tool fully automatically.

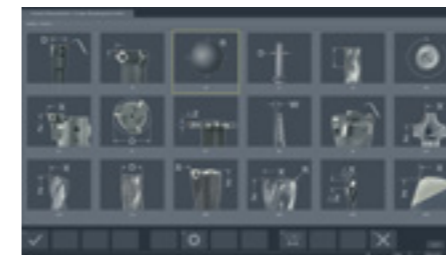

Comprehensive selection of measuring programs in »pilot 4.0« with photo realistic input dialog for simple operation and reliable nominal dimension specification.

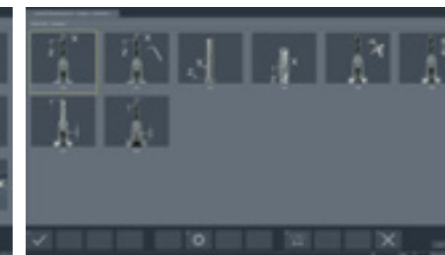

»fored/redomatic« measuring program package for quick and reliable shrink-clamping/adjusting/measurement of various tool types and selection of specialized procedures.

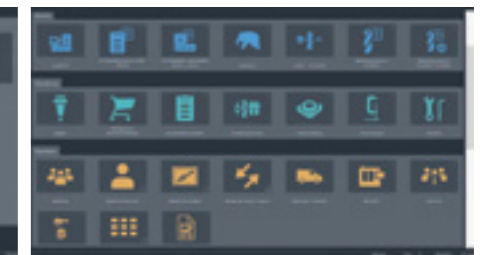

»pilot 4.0« image processing technology uses a modular structure and can be extended up to integration in ZOLLER TMS Tool Management Solutions.

Tool labeling for individual identification

Dynamic crosshairs

Current camera image of the cutting edge

Angle data with selectable reference axis

Nominal values with tolerance information

Current position specifications for the axes

Current active cutting-edge shape



Tool-specific information

Text and graphic storage of adapter management

Automatically detected cutting-edge shapes

Function buttons with self-explanatory icons

Highlights/Hardware of the »redomatic 600«

»ace« High-Precision Spindle

Insert tool, push a button, finished. That's how simple it is to power-operated clamp tools using the universal »ace« high-precision spindle (all-clamping element) from ZOLLER – always with the same precision, accurate and reliable to the last μm . The universal tool holder adapter exchange system makes it possible to exchange in less than 10 seconds between holder systems such as SK, HSK, PSC, VDI, KM or hydroexpansion. No wonder these power-operated high-precision spindles have been impressing users throughout the world for decades.



»asza« length setting system

CNC controlled linear adjusting equipment for adjusting tools to length using a limit pin. Alternatively available as »asza-rot«, with which tool length can be optionally set via the automatic rotation of the length adjusting screw (does not apply for shrink-clamping chucks).



MMS technology

In tools for minimum quantity lubrication (MQL), the coolant transfer piece must be applied to the end of the tool shaft with a positive-locking connection. Only then will you have full functionality and reliability in production with MMS tools. Technology from ZOLLER guarantees secure and positive-locking connection to the coolant supply – fully automatically.

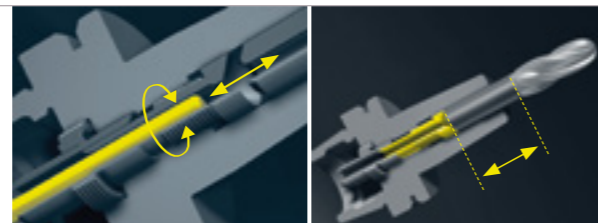

22 kVA induction coil with quick change interface

For shrink-clamping larger shrink-clamping holders diameters D 40 mm to D 50 mm and reinforced shrink-clamping holders (thicker walls). The 22 kVA induction coil can be operated quickly and ergonomically on an alternating basis with the 14 kVA induction coil via a quick exchange interface. The 22 kVA induction coil with shielding washers in diameters D 16 mm to D 20 mm, D 25 mm to D 32 mm and D 40 mm to D 50 mm – these are optionally available in a divided version.



Retractable slide unit

If the »redomatic 600« is not in the tool shrink mode, the »redomatic« slide unit can be lowered automatically to park position via software control. This increases the measurable tool diameter up to D 800 mm.



Cooling bells with »coolbyLight« user guidance

The cooling bells guide you through the cooling process reliably with the help of the color system, switch over LEDs and a cooling time monitoring:

- Steady green: ready for cooling
- Flashing green: the cooling bell to be used
- Steady red: Shrink-clamping holder hot
- Flashing blue: Shrink-clamping holder cooled down



Technical Data and Installation Dimensions



»redomatic 400« technical data

Maximum tool length Z	Measuring range X axis	Maximum clampable shank diameter	Maximum tool diameter D
600 mm	210 / 310 mm	32 mm	420 / 620 mm

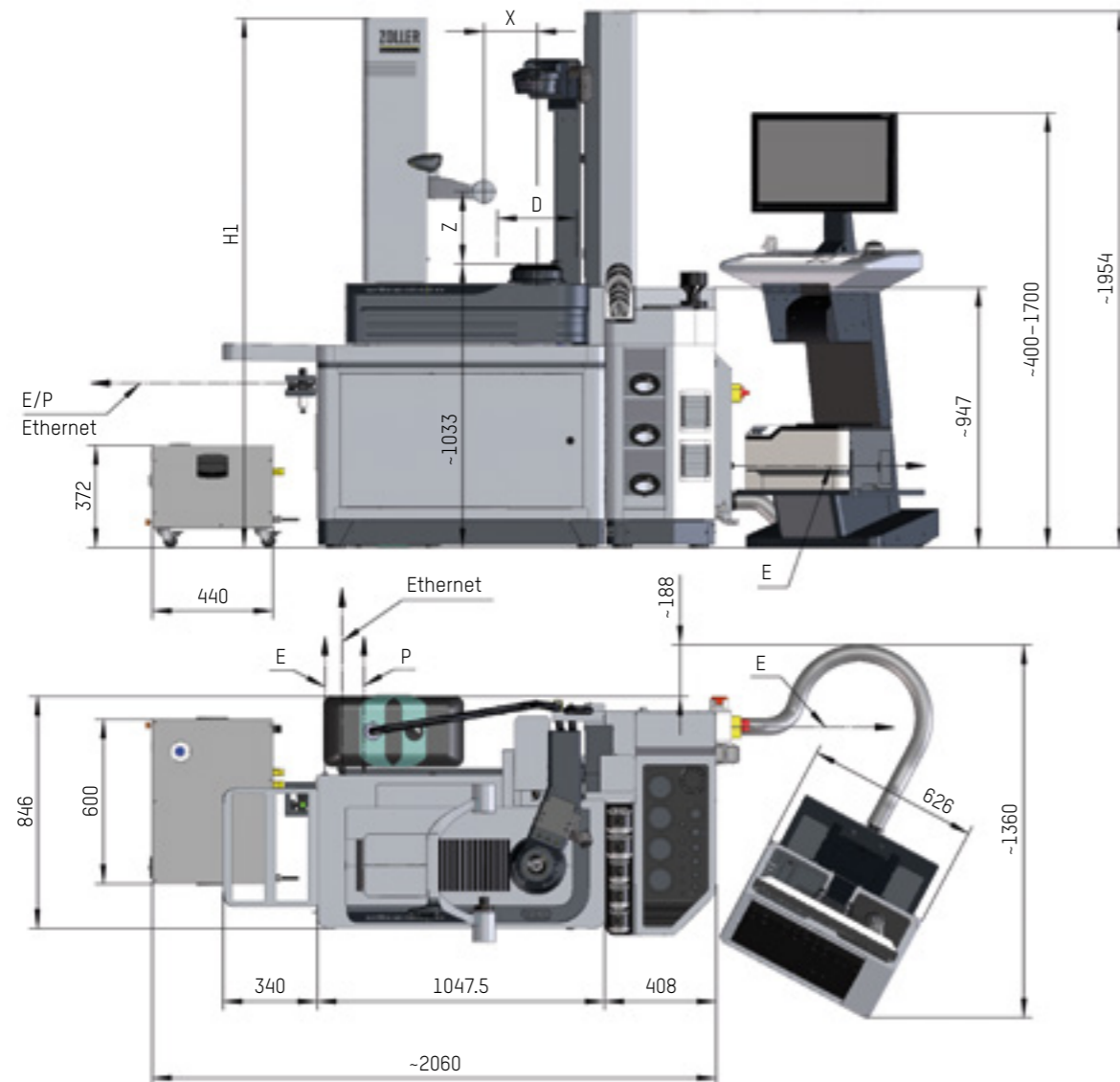

»redomatic 600« technical data

Maximum tool length Z	Measuring range X axis	Maximum clampable shank diameter	Maximum tool diameter D
600 / 800 / 1000 mm	270 / 300 ^[1] / 400 ^[1] mm	32 / 50 ^[2] mm	540 / 600 ^[1] / 800 ^[1] mm

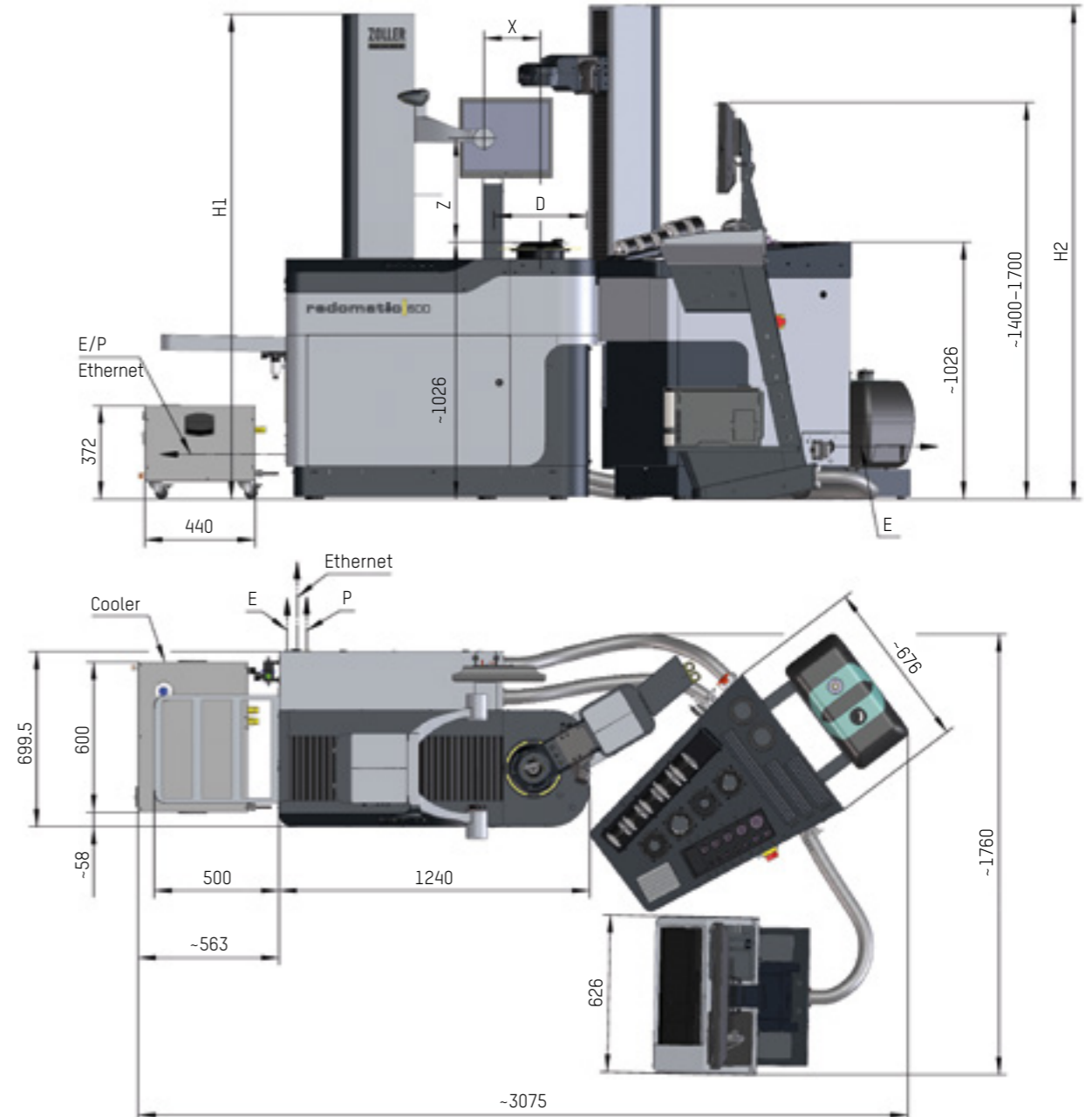

[1] Can only be lowered 570 mm in conjunction with slide unit, maximum clampable shaft diameter 32 mm
 [2] Requirement 22 kVA induction coil

Note: P air connection E electronic connection

Top-Class Stand-Alone Solution: »powerShrink«

Clamping and unclamping tools in record time, while saving energy and conserving holders: You get all these benefits with the inductive »powerShrink« heat shrink system.

Safe, free cooling bell guidance – ensures maximum comfort and safety with the help of a simple fixating mechanism when attaching the cooling bells.

Innovative standard cooling bells – for the rapid cooling of your heat shrink tool holders. High-quality information of the tool diameters provides information about the correspondingly correct cooling bell. The intelligent cooling system, the energy management software, coordinates the cooling times depending on the holder diameter and switches off the cooling module after a defined time. This saves additional energy in the shrink process.

Optionally, the »powerShrink 400« is also available with cooling bells, including »coolbyLight« operator guidance and cooling time monitoring or with »zStream« air cooling.

Robust and smooth work surface – made from stainless steel, offers sufficient space for the heating and cooling of your heat shrink tool holder. The material is optimally aligned to the mounting pot so that shifting the tool is easy, quiet and fast.

Ergonomic storage boards left and right – offers space for positioning cleaning brushes, safety gloves, cooling adapters and holding rings close to the process, thereby rounding off the ergonomic operation of the machine.

Large storage space – offers sufficient space for cooling components and flue gas suction device.

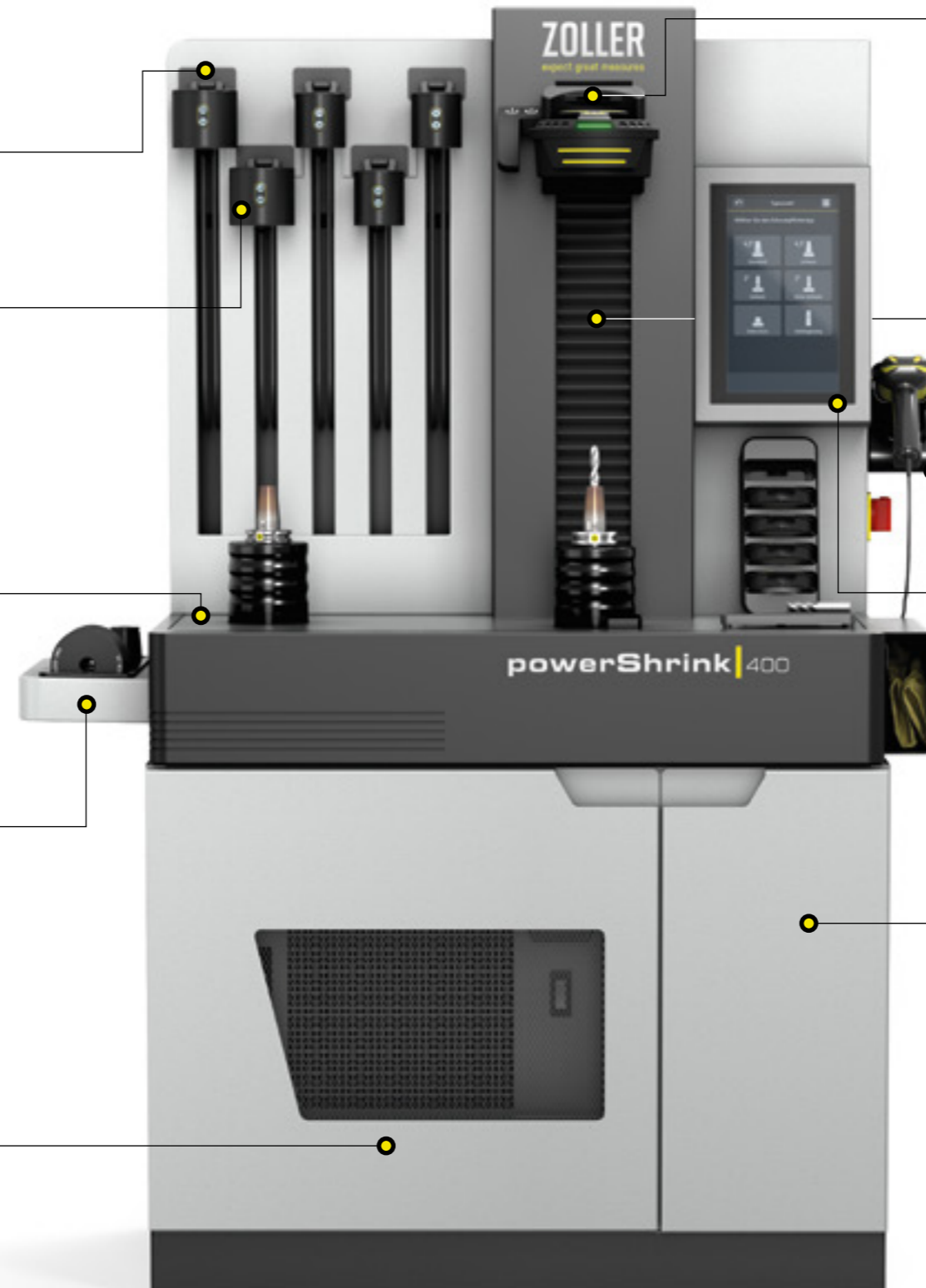

»powerShrink 400« TÜV and UL/CSA approved



The »powerShrink« induction system is certified according to international IEC/EN 61010-1 and cNRTLus standard.

Proven and certified safety.

Intelligent induction coil with shielding system – with ergonomic handle on the left side, including membrane function buttons for moving the coil and activating the heating process.

The »shrinkbyLight« operator guidance system uses LEDs to provide information about which windings are active at the moment and ensures that the correct disc is inserted into the coil for the stored data record. »shrinkbyLight« literally gives the green light for the further shrinking process and, in so doing, ensures maximum safety. The flue gas suction device ensures that the operator is protected.

Optionally, the »powerShrink 400« is available as a shielding system »var0ct«.

Smooth-running induction coil axis – for fast and comfortable movement of the coil. The pneumatic release of the axis clamping, the high-precision THK linear guide and the counterweight allow the operator ergonomic workflows and a long service life. The maximal tool length is 460 mm.

Practical hand scanner – for a rapid and safe start of your shrink-clamping process. Simply scan the DataMatrix code on the ZOLLER »idChip«, and you will immediately have all necessary shrinking parameters available in the »pilot« software.

Industrial 12.5" TFT touch monitor, with ZOLLER »pilot« software – impresses with a razor-sharp display and simple operation via touch. The clearly-structured graphic software interface intuitively guides you through the shrink process, with the help of large function areas and colors.

Optionally, the »powerShrink 400« is also available without monitor and with a control via a membrane keypad.

Stable table – provides the perfect basis for a long-lasting product, thanks to its particularly robust construction. For maintenance and checks, the front door can be opened and the water cooler, mounted on a drawer, can be pulled out.

Optionally, you can get the table on rollers and with an ergonomic handle for flexible positioning of the »powerShrink 400« in your production or as a workbench version without table.

Learn more about ZOLLER »powerShrink«



»roboBox« Automation System

If you use multiple shrink-clamping tools each day, you will benefit immediately from the »roboBox«. With up to six modules, you can individually expand the »roboBox« to create a fully automatic system for fitting, measuring and cooling tools. Your advantages: high throughput, high precision, high tool availability.

»roboBox« can handle all shrink-clamping processes independently with just the combination of the three measuring, shrink-clamping, and cooling modules. Work with tools shrink-clamped to a precise length and exactly measured in fully automatic series production. Unclamp tools quickly that have reached the end of their tool life or that are defective. ZOLLER »roboBox« can be easily integrated into any production and put into operation quickly.



ZOLLER »roboBox« automation system

»roboBox« – Interfaces



In- and output

Regardless of how you infeed and remove your tools, the lock system can always be adjusted to your logistics process: whether manually, using a tool cart or via a transport system.

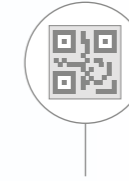

Identification

Tools can be identified optionally with a DataMatrix code or using another tool identification system via RFID Chip.

»roboBox« – Assembly processes



Heat shrinking

The induction coil lowers automatically over the tool holder and heats it. The shaft tool is inserted precisely positioned and then cooled contour-independent in a cooling module, which has capacity to hold up to eight complete tools. This accelerates the cycle time.



Screw fitting collet holders

Matching adapters can be used to automatically clamp the clamping nuts to a defined torque in collet chucks. Switching between clamping adapters is also automatic. Adapters are available for nuts in cylindrical, hexagonal, and fluted versions.



Screw fitting clamping screws

Screws are clamped and released automatically for horizontally arranged clamping screws, like those used on cylinder shaft tools with Weldon areas or hydroexpansion holders. At the same time, the defined torque for the tooling systems is set and monitored.

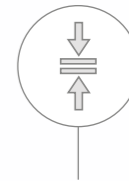

powRgrip® presses

The tool with matching collet holder and REGO-FIX powRgrip® collet holder is infeed and pressed automatically.

»roboBox« – Measurement processes



Tool geometries

After the automatic assembly process, tool geometries such as diameter, length, cutting edge radius, cutting angle and concentricity and axial run-out can be measured in automatic measurement sequences. In addition to automatic mode, manual measurements can also be carried out in the module, during which automatic operation in the »roboBox« is not interrupted.



Balancing quality

The balancing module is insulated with the highly precise measurement unit and integrated into the »roboBox« so as to neutralize vibrations. After the measurement process, the balancing quality can be transferred to the CNC machine control as a measuring parameter.

ZOLLER Smart Factory – Everything from a Single Source

ZOLLER Solutions stand for your future – we make you more successful. If you can manufacture your parts faster and more efficiently, you can work more economically and invest in the future. If economic progress is your goal, then ZOLLER is your partner.



We Stand for ZOLLER Solutions

Your goal is maximum efficiency for your production. Our goal is to support you with well-designed system solutions. To help achieve this goal, we also offer comprehensive service. Whether through personal consultation on site or by developing perfectly tailored solutions for individual requirements – if you choose ZOLLER, you will not only receive excellent products, but also unique production know-how on your side. And of course, competent contact partners to answer questions at any time – over the entire life cycle of the ZOLLER products.

ZOLLER Solutions – With us, you receive more than just outstanding products. You get individual system solutions connected with your tools. We combine hardware, software and services for you. Everything from a single source. Everything for your success. We call it: ZOLLER Solutions.

ALEXANDER ZOLLER, CHRISTOPH ZOLLER
Management



In Germany at Home – Around the World for You

ZOLLER quality is “made in Germany” – and there for you, anywhere in the world.

Our company has its own locations and branches at 85 sites in 62 countries, guaranteeing we are close to customers and can provide first-class, personal customer service in local markets.

- Parent company
- Headquarters
- Branch office
- Representative

GERMANY

HEADQUARTERS

E. ZOLLER GmbH & Co. KG
Einstell- und Messgeräte
Gottlieb-Daimler-Straße 19
D-74385 Pleidelsheim
Tel: +49 7144 8970-0
Fax: +49 7144 8970-70191
post@zoller.info | www.zoller.info

ZOLLER NORTH

E. ZOLLER GmbH & Co. KG
Service- und Vertriebszentrum
D-30179 Hannover

ZOLLER EAST

E. ZOLLER GmbH & Co. KG
Service- und Vertriebszentrum
D-04158 Leipzig

ZOLLER WEST

E. ZOLLER GmbH & Co. KG
Service- und Vertriebszentrum
D-40764 Langenfeld

EUROPE

AUSTRIA

ZOLLER Austria GmbH
A-4910 Ried im Innkreis
office@zoller-a.at | www.zoller-a.at

SWITZERLAND

ZOLLER Schweiz GmbH
CH-9016 St. Gallen
info@zoller-ch.com | www.zoller-ch.com

FRANCE

ZOLLER France
F-67380 Lingolsheim
info@zoller.fr | www.zoller.fr

SPAIN + PORTUGAL

ZOLLER Ibérica S.L.
E-08005 Barcelona
correo@zoller.info | www.zoller.info

TURKEY

ZOLLER Ölçüm Teknolojileri San.ve Tic. Ltd. Sti.
TR-16120 Nilüfer / Bursa
info@zoller-tr.com | www.zoller-tr.com

RUSSIA

LLC ZOLLER Russia
RU-111123 Moscow, Russia
info@zoller-ru.com | www.zoller-ru.com

ISRAEL

ZOLLER Israel GmbH
Ramat Yishay 3009500
info@zoller-il.com | www.zoller.info

POLAND

ZOLLER Polska Sp. z o.o.
63-100 Śrem
biuro@zoller-a.at | www.zoller.net.pl

SLOVAKIA + CZECH REPUBLIC

ZOLLER CZECH s.r.o.
602 02 Brno
suchna@zoller.cz | www.zoller.cz

AMERICA

USA

ZOLLER Inc.
North American Headquarters
USA-48108 Ann Arbor, MI
sales@zoller-usa.com | www.zoller-usa.com

ZOLLER Inc. Pacific

USA-90503 Torrance, CA
sales@zoller-usa.com | www.zoller-usa.com

CANADA

ZOLLER Canada Inc.
CAN-LSN 864 Mississauga, ON
sales@zoller-canada.com | www.zoller-canada.com

MEXICO

ZOLLER Tecnologias S de R.L. de C.V.
MEX-C.P. 76030 San Angel Querétaro
sales@zoller-mexico.com | www.zoller-mexico.com

BRAZIL

ZOLLER do Brasil
BRA-CEP 13284-198 Nova Vinhedo,
Vinhedo - São Paulo
comercial@zoller-br.com | www.zoller-br.com

ASIA

INDIA

ZOLLER India Private Ltd.
IN-Pune 411019 Maharashtra, India
info@zoller-in.com | www.zoller-in.com

CHINA

ZOLLER Shanghai, Ltd.
Asia Pacific Regional Headquarter
RC-201108 Shanghai
info@zoller-cn.com | www.zoller-cn.com

ZOLLER Asia Pacific, Ltd.

RC-Kowloon, Hongkong
info@zoller-cn.com | www.zoller-cn.com

JAPAN

ZOLLER Japan K. K.
JP-564-0037 Osaka, Japan
info@zoller-jp.com | www.zoller-jp.com

THAILAND

ZOLLER (Thailand) Co. Ltd.
Amphur Muang Chonburi, TH-20000 Thailand
info@zoller-in.com | www.zoller-th.com

INDONESIA

ZOLLER Singapore Pte. Ltd
Indonesia Representative Office
Tambun-17510, Bekasi, Jawa Barat
info@zoller-in.com | www.zoller-in.com

SINGAPORE

ZOLLER Singapore Pte. Ltd
SG-199589 Singapore
info@zoller-in.com | www.zoller.info

MALAYSIA

ZOLLER MALAYSIA SDN. BHD.
Malaysia Representative Office
MY-Petaling Jaya | Selangor Darul Ehsan, Malaysia
lau@zoller-my.com | www.zoller-in.com

VIETNAM

ZOLLER Vietnam
VNM-Ho Chi Minh City, Vietnam
info@zoller-in.com | www.zoller-in.com

KOREA

ZOLLER Korea Co., Ltd.
KOR-15119 - Siheung-Si, Gyeonggi-Do, Südkorea
info@zoller-kr.com | www.zoller-kr.com

REPRESENTATIVES

Argentina, Australia, Belarus, Belgium, Bolivia, Chile, Colombia, Costa Rica, Croatia, Denmark, Estonia, Finland, Great Britain, Hungary, Iran, Ireland, Italy, Latvia, Lithuania, Luxembourg, New Zealand, Norway, Pakistan, Peru, Romania, Saudi Arabia, South Africa, Southern Tyrol, Sweden, Taiwan, The Netherlands, United Arab Emirates, Venezuela.



ZOLLER

Solutions

More speed, higher quality, safe processes – with ZOLLER, you increase the efficiency of your production. ZOLLER offers you outstandingly precise devices for adjusting, measuring and testing cutting tools, software, interfaces, cloud services and solutions for the automation of tool processes. You can combine all of this to create your individual system solution – on your way to the smart factory.

Presetting & Measuring

Tool Management

Inspection & Measuring

Automation

Everything from a Single Source.

Everything for your Success.

Everything with ZOLLER Solutions.

ZOLLER
expect great measures

Headquarters in Pleidelsheim

E. ZOLLER GmbH & Co. KG

Tool presetter and measuring machines

Gottlieb-Daimler-Straße 19 | D-74385 Pleidelsheim

Phone: +49 7144 8970-0 | Fax: +49 7144 8970-70191

post@zoller.info | www.zoller.info